

Flexibles hidráulicos

Flexibles hydrauliques
Flexible conductions
Flessibili idrauliche



Mangueras

Tuyaux
Hoses
Tubi flessibili

1

Racores para tubería flexible

Embouts à sertir
Flexible hose fittings
Raccordi per tubi flessibili

2

Manguera Inox, Racores y Bridas soldables

Tuyau Inox, raccords et brides à souder
Stainless steel hose, welding fittings and forged flanges
Tubi Inox, raccordi e flange a saldare

3

Baja presión

Basse pression
Low pressure
Tubi a bassa pressione

4

Aire acondicionado

Climatisation
Air conditioned hoses and fittings
Aria condizionata

5

Metrología

Test du circuit hydraulique
Measuring flow
Test del circuito idraulico

6

Máquinas tratamiento tubo flexible

Machines pour le montage des flexibles
Machines for mounting flexibles
Macchine per l'assemblaggio di tubi flessibili

7

Mangueras

Tuyaux

Hoses

Tubi flessibili

1

Mangueras hidráulicas	8
Tuyaux hydrauliques Hydraulic hoses Tubi idraulici	
Mangueras teflón	9
Tuyaux teflon (PTFE) PTFE hoses Tubi al teflon	
Mangueras industriales	10
Tuyaux industriels Industrial hoses Tubi industriali	
Mangueras termoplásticas	11
Tuyaux thermoplastique Thermoplastic hoses Tubi termoplastici	

Mangueras hidráulicas

Tuyaux hydrauliques | Hydraulic hoses | Tubi idraulici

Hoses

▶ Manguera con malla textil | Tuyau avec tresse textile | Hose with textile braid | Tubi con teccia tessile

13



MB21



ML7010



MB22



M2503



M7000



MB23

Flexible hose fittings

▶ Manguera 1 y 2 mallas | Tuyau 1 et 2 tresses | 1 and 2 Braids hoses | Tubi a 1 e 2 trecce metalliche

14



ML2231



ML3509



M4900



ML2230



ML3511



ML3512

Stainless steel hoses
and fittings

▶ Manguera 4 y 6 mallas | Tuyau 4 et 6 nappes | 4 and 6 Braids hoses | Tubi a 4 e 6 trecce metalliche

15



ML4248/ML4290



M4612



ML4569



M4713



M4815

Low pressure

▶ Manguera hidrolavadoras agua caliente | Tuyau haute pression pour hydronettoyage à l'eau chaude | Hydraulic-wash hoses for hot water | Tubi per idropultrici ad acqua calda

16



MC011 N



MC020 N



MC020 G



MC011 A



MC021 A

Air conditioned hoses
and fittings

Measuring flow

Machines for
mounting flexibles

Mangueras teflón

Tuyaux teflon (PTFE) | PTFE hoses | Tubi al teflon

▶ Teflón liso | Teflon lisse | Smooth PTFE | Teflon liscio

17



M2900



M2912

▶ Teflón coarrugado | Teflon convoluté | Convoluted ptfé | Teflon corrugato

17



M2920

Hoses

Flexible hose fittings

Stainless steel hoses and fittings

Low pressure

Air conditioned hoses and fittings

Measuring flow

Machines for mounting flexibles

Mangueras industriales

Tuyaux industriels | Industrial hoses | Tubi industriali

Hoses

Flexible hose fittings

Stainless steel hoses and fittings

Low pressure

Air conditioned hoses and fittings

Measuring flow

Machines for mounting flexibles

Mangueras para aire y agua | Tuyaux pour air / eau | Air / Water hoses | Tubi aria e acqua



M8000



MA160



MM20



MA1220



MF80



MAS0

Mangueras termoplásticas

Tuyaux thermoplastique | Thermoplastic hoses | Tubi termoplastici

- **Termoplástica malla textil** | Thermoplastique tresse textile | Thermoplastic textile braid | Tubi termoplastici con treccia tessile

18



M0960



M1030



M1000



M1060

- **Termoplástica malla metálica** | Thermoplastique tresse metalique | Thermoplastic metallic braid | Tubi termoplastici con maglia metallica

18



M0870



M0880



M0830



M0810

- **Limpieza de alcantarillas** | Nettoyage des égouts | Sewers cleaning | Tubi per la pulizia di fognature

19



MEC200



MEC250



M3520



Z21200

Mangueras hidráulicas

Tuyaux hydrauliques
Hydraulic hoses
Tubi idraulici

SAE 100 R6



SAE 100 R6
SAE 100 R6
Sae 100 R6

DN	Ø int	REFERENCIA PART N°	€
1/4"	6	MB2104	5,65
5/16"	8	MB2105	6,06
3/8"	10	MB2106	6,53
1/2"	12	MB2108	7,41
5/8"	16	MB2110	8,41
3/4"	19	MB2112	10,88
1"	25	MB2116	14,06

SAE 100 R5



SAE 100 R5
SAE 100 R5
SAE 100 R5

DN	Ø int	REFERENCIA PART N°	€
3/16"	5	M250304	5,68
1/4"	6	M250305	9,00
5/16"	8	M250306	12,29
13/32"	10	M250308	14,47
1/2"	12	M250310	17,82
5/8"	16	M250312	19,53
7/8"	22	M250316	22,53
1"1/8"	28	M250320	33,05
1"3/8"	35	M250324	36,17
1"13/16"	46	M250332	40,11

SAE 100 R4

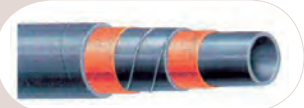

SAE 100 R4
SAE 100 R4
Sae 100 R4

DN	Ø int	REFERENCIA PART N°	€
3/4"	19	ML701019	25,17
1"	25	ML701025	26,88
1"1/4"	32	ML701032	31,58
1"1/2"	38	ML701038	35,41
2"	50	ML701050	48,40
2"1/2"	63	ML701063	69,40

Carbucord 16 bar



Carbucord 16 bar
Carbucord 16 bar
Carbucord 16 bar

Ø ext	Ø int	REFERENCIA PART N°	€
41	30	M70003041	27,94
44	32	M70003243	29,41
54	40	M70004054	42,23
64	50	M70005064	64,69

DIN 20022 2TE / EN 854 2TE



DIN 20022 2TE / EN 854 2TE
DIN 20022 2TE / EN 854 2TE
DIN 20022 2TE / EN 854 2TE

DN	Ø int	REFERENCIA PART N°	€
3/16"	5	MB2203	*
1/4"	6	MB2204	*
5/16"	8	MB2205	*
3/8"	10	MB2206	*
1/2"	12	MB2208	*
5/8"	16	MB2210	*
3/4"	19	MB2212	*
1"	25	MB2216	*

DIN 20022 3TE / EN 854 3TE



DIN 20022 3TE / EN 854 3TE
DIN 20022 3TE / EN 854 3TE
DIN 20022 3TE / EN 854 3TE

DN	Ø int	REFERENCIA PART N°	€
3/16"	5	MB2303	*
1/4"	6	MB2304	*
5/16"	8	MB2305	*
3/8"	10	MB2306	*
5/8"	16	MB2310	*
3/4"	19	MB2312	*
1"	25	MB2316	*
1" 1/4"	32	MB2320	*
1" 1/2"	38	MB2324	*

Mangueras hidráulicas

Tuyaux hydrauliques
Hydraulic hoses
Tubi idraulici

Hoses

Flexible hose fittings

Stainless steel hoses
and fittings

Low pressure

Air conditioned hoses
and fittings

Measuring flow

Machines for
mounting flexibles

SAE 100 R1A / DIN2002 1ST/EN 853 1ST



SAE R1A / DIN 2002 1ST/EN 853 1ST

SAE 100 R1A / DIN 2002 1ST/EN 853 1ST

SAE 100 R1A / DIN 2002 1ST/EN 853 1ST

DN	Ø int	REFERENCIA PART N°	€
3/16"	5	ML223103	5,88
1/4"	6	ML223104	5,65
5/16"	8	ML223105	6,42
3/8"	10	ML223106	7,14
1/2"	12	ML223108	8,76
5/8"	16	ML223110	11,44
3/4"	19	ML223112	12,06
1"	25	ML223116	17,59
1 1/4"	32	ML223120	25,17
1 1/2"	38	ML223124	30,29
2"	50	ML223132	42,29

SAE 100 R1AT/DIN 2002 1SN/EN 853 1SN



SAE 100 R1AT/DIN 2002 1SN/EN 853 1SN

SAE 100 R1AT/DIN 2002 1SN/EN 853 1SN

SAE 100 R1AT/DIN 2002 1SN/EN 853 1SN

DN	Ø int	REFERENCIA PART N°	€
3/16"	5	ML223003	5,59
1/4"	6	ML223004	4,96
5/16"	8	ML223005	5,47
3/8"	10	ML223006	5,76
1/2"	12	ML223008	7,12
5/8"	16	ML223010	9,02
3/4"	19	ML223012	10,53
1"	25	ML223016	15,07
1 1/4"	32	ML223020	25,29
1 1/2"	38	ML223024	29,52
2"	50	ML223032	41,05

SAE 100 R2A/DIN 2002 2ST/EN 853 2ST



SAE 100 R2A/DIN 2002 2ST/EN 853 2ST

SAE 100 R2A/DIN 2002 2ST/EN 853 2ST

SAE 100 R2A/DIN 2002 2ST/EN 853 2ST

DN	Ø int	REFERENCIA PART N°	€
3/16"	5	ML350903	7,76
1/4"	6	ML350904	7,47
5/16"	8	ML350905	8,18
3/8"	10	ML350906	8,65
1/2"	12	ML350908	9,88
5/8"	16	ML350910	12,70
3/4"	19	ML350912	14,94
1"	25	ML350916	22,11
1 1/4"	32	ML350920	34,46
1 1/2"	38	ML350924	40,82
2"	50	ML350932	57,28

SAE 100 R2AT/DIN 2002 2SN/EN 853 2SN

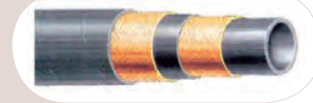

SAE 100 R2AT/DIN 2002 2SN/EN 853 2SN

SAE 100 R2AT/DIN 2002 2SN/EN 853 2SN

SAE 100 R2AT/DIN 2002 2SN/EN 853 2SN

DN	Ø int	REFERENCIA PART N°	€
3/16"	5	ML351103	7,41
1/4"	6	ML351104	6,41
5/16"	8	ML351105	7,14
3/8"	10	ML351106	7,29
1/2"	12	ML351108	8,41
5/8"	16	ML351110	11,53
3/4"	19	ML351112	13,12
1"	25	ML351116	18,82
1 1/4"	32	ML351120	33,64
1 1/2"	38	ML351124	39,82
2"	50	ML351132	52,05

SAE 100 R16



SAE 100 R16

SAE 100 R16

SAE 100 R16

DN	Ø int	REFERENCIA PART N°	€
1/4"	6	M490004	5,63
5/16"	8	M490005	5,93
3/8"	10	M490006	6,66
1/2"	12	M490008	8,60
3/4"	19	M490012	13,92
1"	25	M490016	22,70
1 1/4"	32	M490020	30,29

SAE 100 R2AT / EN853 2SN (antiabrasión)



SAE 100 R2AT / EN853 2SN (antiabrasion)

SAE 100 R2AT / EN853 2SN (antiabrasion)

SAE 100 R2AT / EN853 2SN (antiabrasione)

DN	Ø int	REFERENCIA PART N°	€
1/4"	6	ML351204	9,14
3/8"	10	ML351206	10,59
1/2"	12	ML351208	12,11

Mangueras hidráulicas

Tuyaux hydrauliques
Hydraulic hoses
Tubi idraulici

SAE 100 R9R-R10/DIN 20023 4SP/EN 856 4SP



SAE 100 R9R-R10/DIN 20023 4SP/EN 856 4SP
SAE 100 R9R-R10/DIN 20023 4SP/EN 856 4SP
SAE 100 R9R-R10/DIN 20023 4SP/EN 856 4SP

DN	Ø int	REFERENCIA PART N°	€
1/4"	6	ML429004	18,53
3/8"	10	ML429006	21,58
1/2"	12	ML429008	23,00
5/8"	16	ML429010	26,29
3/4"	19	ML429012	26,82
1"	25	ML429016	33,52
1" 1/4	32	ML424820	52,93
1" 1/2	38	ML424824	69,99
2"	50	ML424832	100,28

DIN 20023 4SH/EN 856 4SH



DIN 20023 4SH/EN 856 4SH
DIN 20023 4SH/EN 856 4SH
DIN 20023 4SH/EN 856 4SH

DN	Ø int	REFERENCIA PART N°	€
3/4"	19	ML456912	28,76
1"	25	ML456916	35,29
1" 1/4	32	ML456920	56,70
1" 1/2	38	ML456924	71,99
2"	50	ML456932	103,81

SAE 100 R12/EN 856 R12



SAE 100 R12/EN 856 R12
SAE 100 R12/EN 856 R12
SAE 100 R12/EN 856 R12

DN	Ø int	REFERENCIA PART N°	€
3/8"	10	M461206	22,17
1/2"	12	M461208	24,64
3/4"	19	M461212	30,23
1"	25	M461216	37,46
1" 1/4	32	M461220	42,26
1" 1/2	38	M461224	72,28
2"	50	M461232	*

SAE 100 R13/EN 856 R13



SAE 100 R13/EN 856 R13
SAE 100 R13/EN 856 R13
SAE 100 R13/EN 856 R13

DN	Ø int	REFERENCIA PART N°	€
3/4"	19	M471312	40,46
1"	25	M471316	52,81
1" 1/4	32	M471320	92,81
1" 1/2	38	M471324	114,57
2"	50	M471332	150,74

SAE 100 R15/SAE J517 R15



SAE 100 R15/SAE J517 R15
SAE 100 R15/SAE J517 R15
SAE 100 R15/SAE J517 R15

DN	Ø int	REFERENCIA PART N°	€
1"	25	M481516	52,93
1" 1/4	32	M481520	92,81
1" 1/2	38	M481524	115,98

Mangueras hidráulicas

Tuyaux hydrauliques
Hydraulic hoses
Tubi idraulici

Hoses

Flexible hose fittings

Stainless steel hoses and fittings

Low pressure

Air conditioned hoses and fittings

Measuring flow

Machines for mounting flexibles

Superservicio agua caliente 1 malla negra



Superservice eau chaude 1 tresse noir
Hot water superservice 1 black braid
Superservice acqua calda a 1 maglia nero

DN	Ø int	REFERENCIA PART N°	€
5/16"	8	MC0115N	5,45
3/8"	10	MC0116N	6,05

Superservicio agua caliente 2 mallas negra



Superservice eau chaude 2 tresses noir
Hot water superservice 2 black braids
Superservice acqua calda a 2 maglie nero

DN	Ø int	REFERENCIA PART N°	€
5/16"	8	MC0205N	6,90
3/8"	10	MC0206N	7,87

Superservicio agua caliente 2 mallas gris



Superservice eau chaude 2 tresses gris
Hot water superservice 2 grey braids
Superservice acqua calda a 2 maglie grigio

DN	Ø int	REFERENCIA PART N°	€
1/4"	6	MC0204G	8,41
5/16"	8	MC0205G	7,45
3/8"	10	MC0206G	8,47

Superservicio agua caliente 1 malla azul



Superservice eau chaude 1 tresse bleu
Hot water superservice 1 blue braid
Superservice acqua calda a 1 maglia azzurro

DN	Ø int	REFERENCIA PART N°	€
5/16	8	MC0115A	6,78
3/8	10	MC0116A	7,38
1/2	12	MC0118A	10,41

Superservicio agua caliente 2 mallas azul



Superservice eau chaude 2 tresses bleu
Hot water superservice 2 blue braids
Superservice acqua calda a 2 maglie azzurro

DN	Ø int	REFERENCIA PART N°	€
5/16"	8	MC0215A	7,93
3/8"	10	MC0216A	8,78

Mangueras teflón

Tuyaux teflon (PTFE)

PTFE hoses

Tubi al teflon

FHL (ligero)



FHL (serie légère)

FHL (light)

FHL (serie leggera)

DN	Ø int	REFERENCIA PART N°	€
3/16"	5	M290005	12,77
1/4"	6	M290006	11,17
5/16"	8	M290008	14,70
3/8"	9	M290009	15,29
13/32"	10	M290010	21,04
1/2"	13	M290013	21,17
5/8"	16	M290016	29,41
3/4"	19	M290020	36,46
1"	25	M290025	55,87

FHM doble malla



FHM 2 tresses

FHM 2 Braids

FHM doppia maglia

DN	Ø int	REFERENCIA PART N°	€
1/4"	6	M2901206	25,75
5/16"	8	M2901208	27,52
3/8"	9	M2901209	32,17
1/2"	13	M2901213	45,59
5/8"	16	M2901216	63,46
3/4"	19	M2901219	76,01
1"	25	M2901225	107,54

Teflón coarrugado



Teflon convoluté

Convuluted PTFE

Teflon corrugato

DN	Ø int	REFERENCIA PART N°	€
1/4"	6	M292006	29,66
3/8"	10	M292009	35,70
1/2"	13	M292013	40,58
5/8"	16	M292016	46,46
3/4"	19	M292020	54,11
1"	25	M292025	79,40
1"1/4	32	M292032	138,21
1"1/2	38	M292038	178,50
2"	50	M292050	209,96

Mangueras termoplásticas

Tuyaux thermoplastique
Thermoplastic hoses
Tubi termoplastici

Hoses

Flexible hose fittings

SAE 100 R7



SAE 100 R7
SAE 100 R7
SAE 100 R7

DN	Ø int	REFERENCIA PART N°	€
1/8"	4	M096002	3,87
3/16"	5	M096003	4,35
1/4"	6	M096004	5,25
5/16"	8	M096005	7,47
3/8"	10	M096006	8,06
1/2"	13	M096008	11,61
5/8"	16	M096010	17,12
3/4"	20	M096012	19,29
1"	25	M096016	29,04

SAE 100 R8



SAE 100 R8
SAE 100 R8
SAE 100 R8

DN	Ø int	REFERENCIA PART N°	€
1/4"	6	M103004	13,52
5/16"	8	M103005	14,79
3/8"	10	M103006	19,45
1/2"	13	M103008	25,76
5/8"	16	M103010	32,17
3/4"	20	M103012	41,18
1"	25	M103016	59,20

SAE 100 R7 Bitubo



SAE 100 R7 Jumelé
SAE 100 R7 Two tubes
SAE 100 R7 Binato

DN	Ø int	REFERENCIA PART N°	€
3/16"	5	M100003	9,91
1/4"	6	M100004	11,82
5/16"	8	M100005	16,22
3/8"	10	M100006	17,38
1/2"	13	M100008	24,49

SAE 100 R8 Bitubo



SAE 100 R8 Jumelé
SAE 100 R8 Two tubes
SAE 100 R8 Binato

DN	Ø int	REFERENCIA PART N°	€
1/4"	6	M106004	28,30
5/16"	8	M106005	30,90
3/8"	10	M106006	40,17
1/2"	13	M106008	52,79

Stainless steel hoses
and fittings

Low pressure

Air conditioned hoses
and fittings

Measuring flow

Machines for
mounting flexibles

Elastómero malla metálica



Elastomère 1 tresse metalique
Metallic braid elastomer
Maglia Metallica

DN	Ø int	REFERENCIA PART N°	€
3/16"	5	M087003	6,41
1/4"	6	M087004	7,42
5/16"	8	M087005	8,37
3/8"	10	M087006	9,65
1/2"	13	M087008	12,24
5/8"	16	M087010	16,22
3/4"	20	M087012	18,29
1"	25	M087016	25,76

Elastómero malla metálica bitubo



Elastomère jumelé 1 tresse metalique
Metallic braid 2 tubes elastomer
Maglia Metallica Binato

DN	Ø int	REFERENCIA PART N°	€
3/16"	5	M088003	14,15
1/4"	6	M088004	16,06
5/16"	8	M088005	18,02
3/8"	10	M088006	20,62
1/2"	13	M088008	25,76

Mangueras termoplásticas

Tuyaux thermoplastique
Thermoplastic hoses
Tubi termoplastici

Elastómero malla metálica pintura



Elastomère especial peinture 1 tresse metalique
Paint metallic braid elastomer
Maglia Metallica per vernici

DN	Ø int	REFERENCIA PART N°	€
3/16"	5	M083003	6,63
1/4"	6	M083004	7,63
3/8"	10	M083006	9,91
1/2"	13	M083008	12,61
3/4"	20	M083012	18,76

Elastómero doble malla metálica pintura



Elastomère especial peinture 2 tresses metaliques
Paint metallic braid 2 tubes elastomer
Doppia Maglia Metallica per vernici

DN	Ø int	REFERENCIA PART N°	€
1/4"	6	M081004	12,77
3/8"	10	M081006	18,60
1/2"	13	M081008	21,52

Ecology 200



Ecology 200
Ecology 200
Ecology 200

DN	Ø int	REFERENCIA PART N°	€
3/4"	20	MEC20012	27,56
1"	25	MEC20016	36,52
1" 1/4	32	MEC20020	40,55

Manguera termoplástica 700 bar



Tuyau thermoplastique haute pression 700 bar
Thermoplastic hose 700 bar
Tubo termoplastico 700 bar

DN	Ø int	REFERENCIA PART N°	€
1/4"	6	M352004	21,61

Ecology 250



Ecology 250
Ecology 250
Ecology 250

DN	Ø int	REFERENCIA PART N°	€
3/4"	20	MEC25012	40,55
1"	25	MEC25016	56,76

Casquillos para manguera Ecology

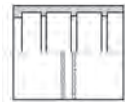

Jupes pour tuyau Ecology
Ferrules for Ecology hose
Boccole pressare per tubi Ecologici

DN	REFERENCIA PART N°	€
3/4"	Z212001200	33,10
1"	Z212001600	45,20
1"1/4	Z212002000	69,68

Mangueras industriales

Tuyaux industriels
Industrial hoses
Tubi industriali

Hoses

Flexible hose fittings

Stainless steel hoses and fittings

Low pressure

Air conditioned hoses and fittings

Measuring flow

Machines for mounting flexibles

Ariaform aire comprimido y agua-impulsión serie continua

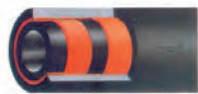

Ariaform refolement air comprimé et de l'eau
Ariaform compressed air and water. continuous
Aria compressa e acqua-impulsi. Serie continua

DN	Ø ext	Ø int	REFERENCIA PART N°	€
1/4"	14	6	M80000614	2,18
5/16"	17	8	M80000817	2,94
3/8"	17	10	M80001017	3,82
1/2"	21	13	M80001321	4,47
5/8"	26	16	M80001626	6,47
3/4"	29	19	M80001929	7,06

Aire comprimido-impulsión



Air comprimé
Compressed air
Aria compressa

Ø int	REFERENCIA PART N°	€
25	MA122025	15,64
32	MA122032	20,94
40	MA122040	25,70
51	MA122051	31,41

Agua caliente para limpieza industrial



Tuyau pour nettoyage á l'eau chaude
Industrial cleaning hoses. Hot water
Acqua calda per pulizia industriale 160°C

DN	Ø int	REFERENCIA PART N°	€
5/8"	16	MA1601628	17,82
3/4"	19	MA1601931	19,47
1"	25	MA1602538	24,94

Fumigación serie continua



Tuyau fumigation
Fumigation hose. Continuous serie
Fumigazione. Serie continua

DN	Ø int	REFERENCIA PART N°	€
3/8"	10	MF8010	4,18
1/2"	12	MF8012	5,41

Polivalente serie continua



Tuyau polyvalent huiles/carburants
Multi-function. Continuous serie
Polivalente. Serie continua

DN	Ø int	REFERENCIA PART N°	€
5/16"	8	MM2008	3,59
3/8"	10	MM2010	4,59
1/2"	13	MM2013	5,59
5/8"	16	MM2016	7,70
3/4"	19	MM2019	8,47

Mangueras alimentarias



Tuyaux alimentaires
Food Hoses
Tubi alimentare

DN	Ø int	REFERENCIA PART N°	€
1"	25	MAS025	32,52
1" 1/4	32	MAS032	38,93
1" 1/2	38	MAS038	42,40
2"	51	MAS051	55,40
2" 1/2	63	MAS063	69,58
3"	76	MAS076	92,57

Tabla de roscas

Tableau des raccords | Table port thread | Tabelle dei filetti

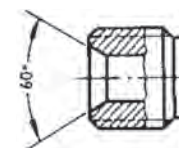
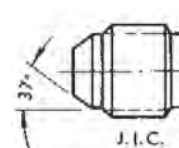
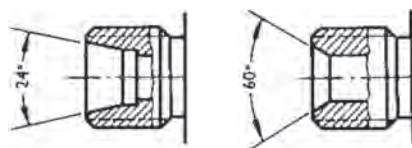

Métrica Métrique Metrical Metrica	Ø ext.	Ø int.	Cono 24° 24° Cone	Cono 24° Cono 24°	Cono 60° 60° Cone	Cono 60° Cono 60°
12 x 1,5	12	10,05	•		•	
14 x 1,5	14	12,05	•		•	
16, x 1,5	16	14,05	•		•	
18 x 1,5	18	16,05	•		•	
20 x 1,5	20	18,05	•		•	
22 x 1,5	22	20,05	•		•	
24 x 1,5	24	22,05	•		•	
26 x 1,5	26	24,05	•		•	
30 x 1,5	30	28,05			•	
30 x 2	30	27,40	•			
36 x 2	36	33,40	•			
38 x 1,5	38	36,05			•	
42 x 2	42	39,40	•			
45 x 1,5	45	43,05			•	
45 x 2	45	42,40	•			
52 x 1,5	52	50,05			•	
52 x 2	52	49,40	•			
65 x 2	65	64,40			•	
78 x 2	78	75,40			•	

SAE	Ø ext.	Ø int.	BSP	Ø ext.	Ø int.
7/16-20	11,07	10,00	1/4-19	13,16	11,50
1/2-20	12,70	11,60	3/8-19	16,66	14,90
9/16-18	14,25	13,00	1/2-14	20,96	18,60
5/8-18	15,85	14,70	5/8-14	22,91	20,60
3/4-16	19,00	17,60	3/4-14	26,44	24,10
7/8-14	22,17	20,50	1-11	33,25	30,30
1 1/16-12	26,95	25,00	1 1/4-11	41,91	38,90
1 1/16-14	26,95	25,30	1 1/2-11	47,80	44,90
1 5/16-12	33,30	31,30	2-11	59,62	56,70
1 5/16-14	33,30	31,60			
1 5/8-12	41,42	39,20			
1 5/8-14	41,22	39,50			
1 7/8-12	47,57	45,60			
1 7/8-14	47,57	45,90			
2 1/2-12	63,45	61,50			
3-12	76,20	74,30			

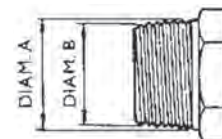

NPT Cónicas NPT conique Conical NPT NPT conico	Ø A	Ø B	BSPT Cónicos BSPT conique Conical BSPT BSPT conico	Ø A	Ø B
1/8-27	10,59	9,98	1/8-28	10,20	9,48
1/4-18	14,12	13,28	1/4-19	13,90	12,85
3/8-18	17,55	16,71	3/8-19	17,31	16,26
1/2-14	21,84	21,08	1/2-14	21,89	20,55
3/4-14	27,17	26,13	3/4-14	27,30	25,84
1-11,5	33,96	32,74	1-11	34,41	32,65
1 1/4-11,5	42,72	41,47	1 1/4-11	42,91	41,11
1 1/2-11,5	48,81	47,54	1 1/2-11	48,83	47,08
2-11,5	60,88	59,56	2-11	60,94	58,62

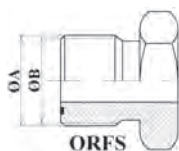

ORFS	Ø B (mm)	Ø A (mm)
9/16" 18h	13,0	14,25
11/16" 16h	15,4	17,40
13/16" 16h	18,6	20,05
1" 14h	23,1	25,30
1" 3/16 12h	27,5	30,10
1" 7/16 12h	33,8	36,40
1" 11/16 12h	40,2	42,80
2" 12h	48,1	50,70

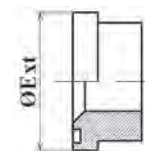

Brida SAE	Ø Ext. 3000 PSI	Ø Ext. 6000 PSI
1/2"	30,2	31,8
3/4"	38,1	41,3
1"	44,5	47,6
1" 1/4	50,8	54,0
1" 1/2	60,3	63,5
2"	71,4	79,4

* Las bridas 9000 PSI son iguales en Ø a las 6000 PSI, pero con espesor de pletina 14,3 | Les brides 9000 PSI son égales en Ø aux brides 6000 PSI, mais l'épaisseur est de 14,3 mm. 9000 PSI flanges have the same Ø as 6000 PSI, but with thickness deck 14,3 | Le flange 9000 PSI hanno il medesimo Ø della serie 6000 PSI, cambia unicamente lo spessore a 14,3 mm.

Racores para tubería flexible

Embouts à sertir

Flexible hose fittings

Raccordi per tubi flessibili



Conexiones Standard	24
Embouts serie Standard Standard serie fittings Raccordi serie Standard	
Conexiones Interlock	27
Embouts à sertir Interlock Interlock serie fittings Raccordi serie Interlock	
Conexiones Reusables	29
Embouts Récuperables Reusable serie fittings Raccordi serie Recuperabile	
Conexiones alta presión (700 Bar)	30
Embouts haute pression 700 Bar High pressure 700 Bar fittings Raccordi Altissima pressione (700 Bar)	

Conexiones Standard

Embouts serie Standard | Standard serie fittings | Raccordi serie Standard

Hoses

Casquillos para prensar | Jupes à sertir | Crimp ferrules | Boccole a pressare

31

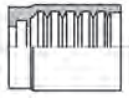

PF2212



PF1224

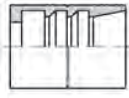

22003



21040



21041

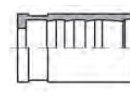

21012/PF23

Flexible hose fittings

Conexiones BSP | Embouts BSP | BSP Fittings | Raccordi BSP

32



24100



24100...L

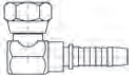

24127



24110



24200



24107



24107...L



24117



24108



24108...L



24118



24161



24112



24114



24212

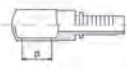

24111



A1090

Stainless steel hoses and fittings

Low pressure

Conexiones JIC 37° | Embouts JIC 37° | JIC 37° Fittings | Raccordi JIC 37°

35



24140



24142



24138



24139

Air conditioned hoses and fittings

Measuring flow

Conexiones Métricas DIN 2353 | Embouts Métriques DIN 2353 | Metric fittings DIN 2353 | Raccordi Metrici DIN 2353

36

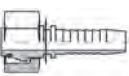

24804



24305



24306



24203



24190



24158



24300



24258

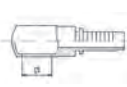

24116



24358

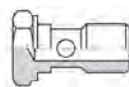

S1092

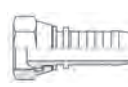

24404



24406

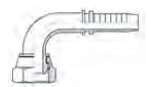

24405

Conexiones Métricas Serie Japonesa | Embouts Métriques Série Japonaise | Metric fittings Japanese Serie | Raccordi Metrici Serie Giappone

39



2580496

Machines for mounting flexibles

▶ **Conexiones Métricas Serie Francesa** | Embouts Métriques Série Française | Metric fittings French Serie | Raccordi Metrici Serie Francese 39



24503 2450518 24504 24505

▶ **Bridas SAE** | Brides SAE | SAE Flanges | Flange SAE 40

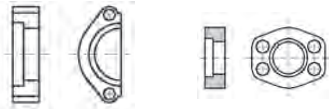

AFS AFSI

▶ **Bridas SAE 3000/6000 PSI** | Brides SAE 3000/6000 PSI | 3000/6000 PSI SAE Flanges | Flange SAE 3000/6000 PSI 41



24182 24183 24184 24282 24283 24284

▶ **Bridas Caterpillar** | Embouts brides Caterpillar | 9000 PSI Caterpillar Flanges | Flange Caterpillar 42



44282 44284 44283

▶ **Juntas para bridas** | Joints pour brides | Seals for flanges | O'Ring per flange 42



JUNTAS JBR

▶ **Pletinas de bridas Poclairn** | Embouts brides type Poclairn | Poclairn Flanges | Flange Poclairn 43

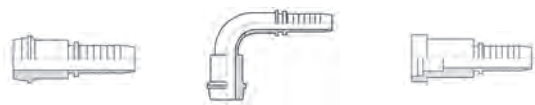

44801 44803 44802

▶ **Bridas Poclairn** | Brides Poclairn | Poclairn Flanges | Flange Poclairn 43



44805 44807 44806 44808

▶ **Conexiones ORFS** | Embouts ORFS | ORFS Fittings | Raccordi ORFS 44



44900 44912 44907 44908 JUNTAS

Hoses

Flexible hose fittings

Stainless steel hoses and fittings

Low pressure

Air conditioned hoses and fittings

Measuring flow

Machines for mounting flexibles

▶ **Racores para hidrolavadoras** | Embouts pour hydronettoyage | Hydraulic-wash fittings | Raccordi per idropulitrici



23040



23060



23061

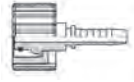

230700



23062

Conexiones Interlock

Embouts à sertir Interlock | Interlock serie fittings | Raccordi serie Interlock

► **Casquillos** | Jupes | Crimp ferrules | Boccole a pressare

46



A61010



61010

► **Conexiones BSP** | Embouts BSP | BSP Fittings | Raccordi BSP

46



64100



64107



64108



64112



64161

► **Conexiones JIC 37°** | Embouts JIC 37° | JIC 37° Fittings | Raccordi JIC 37°

47



64142



64139



64138



64140

► **Conexiones Métricas DIN 2353** | Embouts Métriques DIN 2353 | Metric fittings DIN 2353 | Raccordi Metrici DIN 2353

47



64204



64206



64205



64203

► **Bridas SAE 3000/6000 PSI** | Embouts brides SAE 3000/6000 PSI | SAE Flanges | Flange SAE

48



64182



64183



64184



64282



64283



64284

► **Bridas Caterpillar** | Embouts brides Caterpillar | 9000 PSI Caterpillar flanges | Flange Caterpillar

49



64382



64384



64383

► **Bridas Poclair** | Embouts brides Poclair | Poclair Flanges | Flange Poclair

49



64801



44805



64802



44806



44807



44808

Hoses

Flexible hose fittings

Stainless steel hoses and fittings

Low pressure

Air conditioned hoses and fittings

Measuring flow

Machines for mounting flexibles

▶ **Conexiones ORFS** | Embouts ORFS | ORFS fittings | Raccordi ORFS

50



64900



64908



64907

▶ **Racores para martillo** | Embouts pour marteau | Fittings for hammer | Raccordi per martelli

50

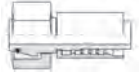

NAM

Conexiones Reusables

Embouts Récuperables | Reusable serie fittings | Raccordi serie Recuperabile

▶ Casquillos | Jupes | Ferrules | Boccole recuperabili

51

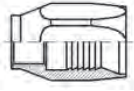

A1G/R1A

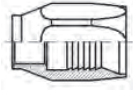

A1G/R2A

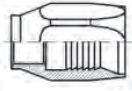

A1G/R2T

▶ Conexiones | Embouts | Fittings | Raccordi recuperabili

51



A3G



A90G



A2G



S2G



AE



AOG

Hoses

Flexible hose fittings

Stainless steel hoses and fittings

Low pressure

Air conditioned hoses and fittings

Measuring flow

Machines for mounting flexibles

Conexiones alta presión (700 Bar)

Embouts haute pression 700 Bar | High pressure 700 Bar fittings | Raccordi Altissima pressione (700 Bar)

Hoses

Casquillos | Jupes à sertir | Ferrules | Boccole

53



M3520



71012

Flexible hose fittings

Conexiones BSP | Embouts BSP | BSP Fittings | Raccordi BSP

53



74100



74112



74161

Stainless steel hoses
and fittings

Conexiones JIC 37° | Embouts JIC 37° | JIC 37° Fittings | Raccordi JIC 37°

53



74142

Low pressure

Air conditioned hoses
and fittings

Measuring flow

Machines for
mounting flexibles

Conexiones Standard

Embouts serie Standard
Standard serie fittings
Raccordi serie Standard

Casquillos R1AT/R2AT 1SN/2SN



Jupes à sertir R1AT/R2AT 1SN/2SN
Ferrules R1AT/R2AT 1SN/2SN

Boccole a pressare per R1AT/R2AT 1SN/2SN

DN	REFERENCIA PART N°	€
3/16"	PF221200300	1,17
1/4"	PF221200400	0,90
5/16"	PF221200500	1,07
3/8"	PF221200600	1,06
1/2"	PF221200800	1,27
5/8"	PF221201000	2,20
3/4"	PF221201200	2,77
1"	PF221201600	4,82
1"1/4	PF221202000	10,68
1"1/2	PF221202400	16,23
2"	PF221203200	25,92

Casquillos Teflón Liso alta presión



Jupes à sertir pour Teflon Lisse haute pression

Ferrules for Smooth PTFE

Boccole a pressare per tubo al Teflon Liscio alta pressione

DN	REFERENCIA PART N°	€
3/16"	210400300	1,41
1/4"	210400400	1,08
5/16"	210400500	1,35
3/8"	210400600	1,23
1/2"	210400800	1,51
5/8"	210401000	1,88
3/4"	210401200	2,38
1"	210401600	3,75

Casquillos R2A-2ST / DIN 20023 4SP



Jupes à sertir R2A-2ST / DIN 20023 4SP

Ferrules R2A-2ST / DIN 20023 4SP

Boccole a pressare per R2A-2ST / DIN 20023 4 SP

DN	REFERENCIA PART N°	€
3/16"	PF122400300	1,49
1/4"	PF122400400	0,89
5/16"	PF122400500	1,19
3/8"	PF122400600	1,13
1/2"	PF122400800	1,39
5/8"	PF122401000	2,41
3/4"	PF122401200	2,77
1"	PF122401600	4,82
1"1/4	PF122402000	10,81
1"1/2	PF122402400	16,23
2"	PF122403200	25,84

Casquillos Teflón Coarrugado alta presión



Jupes à sertir Teflon Convoluté haute pression

Ferrules for Convolutated PTFE

Boccole a pressare per tubo al Teflon Coarrugado alta pressione

DN	REFERENCIA PART N°	€
1/4"	210410400	1,33
3/8"	210410600	1,72
1/2"	210410800	1,73
5/8"	210411000	2,66
3/4"	210411200	3,06
1"	210411600	5,27
1"1/4	210412000	11,01
1"1/2	210412400	13,38
2"	210413200	18,14

Casquillos R1A

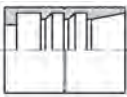

Jupes à sertir pour R1A

Ferrules R1A

Boccole a pressare per R1A

DN	REFERENCIA PART N°	€
3/16"	220030300	1,31
1/4"	220030400	1,00
5/16"	220030500	1,07
3/8"	220030600	1,17
1/2"	220030800	1,63
5/8"	220031000	2,29
3/4"	220031200	3,02
1"	220031600	5,00
1"1/4	220032000	9,71
1"1/2	220032400	11,32
2"	220033200	25,67

Casquillos R7, R8 y malla metálica

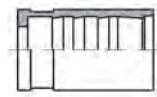

Jupes à sertir R7, R8 et tresse métallique

Ferrules SAE 100 R7, R8 and metallic braid

Boccole a pressare per SAE R7, R8 e Treccia Metallica

DN	REFERENCIA PART N°	€
1/8"	210120200	1,33
3/16"	PF2300300	0,88
1/4"	PF2300400	0,82
5/16"	PF2300500	1,12
3/8"	PF2300600	1,08
1/2"	PF2300800	1,54
5/8"	210121000	3,34
3/4"	210121200	3,49
1"	210121600	6,77

Conexiones Standard

Embouts serie Standard
Standard serie fittings
Raccordi serie Standard

Hoses

Hembras giratorias rectas cono 60°

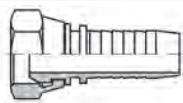

Embout femelle tournante gaz cyl BSP 60°
BSP Swivel female 60° cone
Femmina diritta BSP sede 60°

DN	ROSCA THREAD	REFERENCIA PART N°	€
1/8"	1/8" BSP	241000202	2,46
3/16"	1/8" BSP	241000203	2,17
1/4"	1/8" BSP	241000204	1,97
3/16"	1/4" BSP	241000403	1,93
1/4"	1/4" BSP	241000404	1,06
5/16"	1/4" BSP	241000405	1,75
3/8"	1/4" BSP	241000406	2,81
1/4"	3/8" BSP	241000604	1,63
5/16"	3/8" BSP	241000605	1,49
3/8"	3/8" BSP	241000606	1,32
1/2"	3/8" BSP	241000608	2,32
1/4"	1/2" BSP	241000804	2,59
3/8"	1/2" BSP	241000806	1,95
1/2"	1/2" BSP	241000808	1,91
5/8"	1/2" BSP	241000810	5,08
1/2"	5/8" BSP	241001008	4,12
5/8"	5/8" BSP	241001010	3,76
1/2"	3/4" BSP	241001208	3,53
5/8"	3/4" BSP	241001210	3,53
3/4"	3/4" BSP	241001212	2,99
3/4"	1" BSP	241001612	5,62
1"	1" BSP	241001616	5,12

Para aquellas mayores de 1" ver con junta // Pour ceux plus grand que 1" voir avec o'ring
// For those bigger than 1" see with o'ring // Per quelli più grandi di 1" vedere con o'ring

Flexible hose fittings

Stainless steel hoses
and fittings

Low pressure

Air conditioned hoses
and fittings

Measuring flow

Machines for
mounting flexibles

Hembras giratorias rectas cono 60° con junta tórica



Embout femelle tournant droit gaz cyl BSP 60° + o'ring
BSP Swivel female 60° with o'ring
Femmina diritta BSP sede 60° con o'ring

DN	ROSCA THREAD	REFERENCIA PART N°	€
1/4"	1/4" BSP	241100404	1,60
3/8"	3/8" BSP	241100606	1,56
1/2"	1/2" BSP	241100808	2,52
5/8"	5/8" BSP	241101010	11,27
5/8"	3/4" BSP	241101210	4,15
3/4"	3/4" BSP	241101212	4,04
1"	1" BSP	241101616	7,86
1"	1 1/4" BSP	241102016	11,75
1 1/4"	1 1/4" BSP	241102020	12,40
1 1/4"	1 1/2" BSP	241102420	29,45
1 1/2"	1 1/2" BSP	241102424	17,09
1 1/2"	2" BSP	241103224	49,14
2"	2" BSP	241103232	30,93

Hembras giratorias rectas asiento plano



Embout femelle tournant fond plat BSP
BSP Swivel female flat seat
Femmina diritta BSP sede piana

DN	ROSCA THREAD	REFERENCIA PART N°	€
1/4"	1/4" BSP	242000404	1,63
5/16"	3/8" BSP	242000605	2,73
3/8"	3/8" BSP	242000606	2,73
3/8"	1/2" BSP	242000806	3,57
1/2"	1/2" BSP	242000808	3,54
1/2"	3/4" BSP	242001208	7,12
3/4"	3/4" BSP	242001212	8,10
1"	1" BSP	242001616	12,22

Hembras giratorias 90° cono 60°

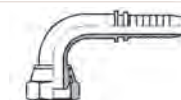

Embout coude 90° femelle tournant gaz cyl BSP 60°
90° BSP Swivel female 60° cone
Femmina a 90° BSP sede 60°

DN	ROSCA THREAD	REFERENCIA PART N°	€
3/16"	1/8" BSP	241070203	4,10
1/4"	1/8" BSP	241070204	4,79
3/16"	1/4" BSP	241070403	4,79
1/4"	1/4" BSP	241070404	1,44
1/4"	3/8" BSP	241070604	3,41
5/16"	3/8" BSP	241070605	3,01
3/8"	3/8" BSP	241070606	2,24
1/4"	1/2" BSP	241070804	3,75
3/8"	1/2" BSP	241070806	3,10
1/2"	1/2" BSP	241070808	3,10
1/2"	5/8" BSP	241071008	7,45
5/8"	5/8" BSP	241071010	7,06
1/2"	3/4" BSP	241071208	5,62
5/8"	3/4" BSP	241071210	8,83
3/4"	3/4" BSP	241071212	5,26
3/4"	1" BSP	241071612	9,81
1"	1" BSP	241071616	9,30

Para aquellas mayores de 1" ver con junta // Pour ceux plus grand que 1" voir avec o'ring
// For those bigger than 1" see with o'ring // Per quelli più grandi di 1" vedere con o'ring

Hembras giratorias rectas cono 60° tuerca libre



Embout femelle tournant droit gaz cyl BSP 60°
BSP Swivel female 60° cone-loose nut
Femmina diritta BSP sede 60° dado libero

DN	ROSCA THREAD	REFERENCIA PART N°	€
1/4"	1/4" BSP	241000404L	1,17
1/4"	3/8" BSP	241000604L	2,34
5/16"	3/8" BSP	241000605L	1,84
3/8"	3/8" BSP	241000606L	1,50
3/8"	1/2" BSP	241000806L	2,49
1/2"	1/2" BSP	241000808L	2,15

Hembras giratorias 90° cono 60° (compactas)

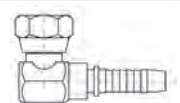

Embout coude 90° femelle tournant compact gaz cyl BSP 60°
90° BSP Swivel female 60° cone (compact)
Femmina a 90° BSP sede 60° (compatta)

DN	ROSCA THREAD	REFERENCIA PART N°	€
1/4"	1/4" BSP	241270404	3,17
3/8"	3/8" BSP	241270606	4,15
1/2"	1/2" BSP	241270808	5,05
3/4"	3/4" BSP	241271212	12,06

Conexiones Standard

Embouts serie Standard
Standard serie fittings
Raccordi serie Standard

Hembras giratorias 90° cono 60° tuerca libre

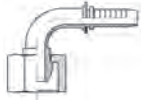

Embout coude 90° femelle tournant gaz cyl BSP 60°
90° BSP Swivel female 60° cone-loose nut
Femmina a 90° BSP sede 60° dado libero

DN	ROSCA THREAD	REFERENCIA PART N°	€
1/4"	1/4" BSP	241070404L	2,08
1/4"	3/8" BSP	241070604L	3,46
5/16"	3/8" BSP	241070605L	3,68
3/8"	3/8" BSP	241070606L	2,71
3/8"	1/2" BSP	241070806L	4,46
1/2"	1/2" BSP	241070808L	3,68

Hembras giratorias 45° cono 60° tuerca libre

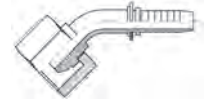

Embout coude 45° femelle tournant gaz cyl BSP 60°
45° BSP Swivel female 60° cone-loose nut
Femmina a 45° BSP sede 60° dado libero

DN	ROSCA THREAD	REFERENCIA PART N°	€
1/4"	1/4" BSP	241080404L	2,61
1/4"	3/8" BSP	241080604L	5,19
5/16"	3/8" BSP	241080605L	5,19
3/8"	3/8" BSP	241080606L	3,29
3/8"	1/2" BSP	241080806L	4,78
1/2"	1/2" BSP	241080808L	4,32

Hembras giratorias 90° cono 60° con junta tórica



Embout coude 90° femelle tournant gaz cyl BSP 60° + o'ring
90° BSP Swivel female 60° cone with o'ring
Femmina a 90° BSP sede 60° con o'ring

DN	ROSCA THREAD	REFERENCIA PART N°	€
1/4"	1/4" BSP	241170404	3,69
3/8"	3/8" BSP	241170606	4,29
1/2"	1/2" BSP	241170808	5,73
5/8"	5/8" BSP	241171010	24,57
3/4"	3/4" BSP	241171212	12,20
1"	1" BSP	241171616	20,98
1"	1"1/4" BSP	241172016	29,87
1"1/4"	1"1/4" BSP	241172020	29,71
1"1/4"	1"1/2" BSP	241172420	59,53
1"1/2"	1"1/2" BSP	241172424	49,27
2"	2" BSP	241173232	101,97

Hembras giratorias 45° cono 60° con junta tórica

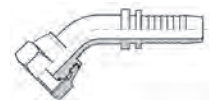

Embout coude 45° femelle tournant gaz cyl BSP 60° + o'ring
45° BSP Swivel female 60° cone with o'ring
Femmina a 45° BSP sede 60° con o'ring

DN	ROSCA THREAD	REFERENCIA PART N°	€
5/8"	5/8" BSP	241181010	24,99
5/8"	3/4" BSP	241181210	10,58
3/4"	3/4" BSP	241181212	13,35
1"	1" BSP	241181616	21,10
1"1/4"	1"1/4" BSP	241182020	26,90
1"1/4"	1"1/2" BSP	241182420	68,17
1"1/2"	1"1/2" BSP	241182424	55,29
1"1/2"	2" BSP	241183224	113,52
2"	2" BSP	241183232	94,04

Hembras giratorias 45° cono 60°

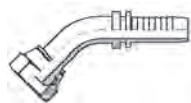

Embout coude 45° femelle tournant gaz cyl BSP 60°
45° BSP Swivel female 60° cone
Femmina a 45° BSP sede 60°

DN	ROSCA THREAD	REFERENCIA PART N°	€
3/16"	1/8" BSP	241080203	5,17
1/4"	1/8" BSP	241080204	6,54
3/16"	1/4" BSP	241080403	5,96
1/4"	1/4" BSP	241080404	2,86
1/4"	3/8" BSP	241080604	3,90
5/16"	3/8" BSP	241080605	4,81
3/8"	3/8" BSP	241080606	3,12
3/8"	1/2" BSP	241080806	4,78
1/2"	1/2" BSP	241080808	4,84
1/2"	5/8" BSP	241081008	9,41
5/8"	5/8" BSP	241081010	7,90
5/8"	3/4" BSP	241081210	10,83
3/4"	3/4" BSP	241081212	8,05
3/4"	1" BSP	241081612	16,86
1"	1" BSP	241081616	14,59

Macho rosca cónica NPT

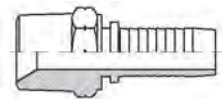

Embout mâle fixe gaz conique NPT
NPT Male thread
Maschio NPT conico

DN	ROSCA THREAD	REFERENCIA PART N°	€
3/16"	1/8" NPT	241610203	2,54
1/4"	1/8" NPT	241610204	2,12
1/4"	1/4" NPT	241610404	1,69
1/4"	3/8" NPT	241610604	2,88
5/16"	3/8" NPT	241610605	2,71
3/8"	3/8" NPT	241610606	2,54
1/2"	3/8" NPT	241610608	3,34
3/8"	1/2" NPT	241610806	2,85
1/2"	1/2" NPT	241610808	2,85
5/8"	1/2" NPT	241610810	5,02
1/2"	3/4" NPT	241611208	9,96
3/4"	3/4" NPT	241611212	4,39
3/4"	1" NPT	241611612	11,01
1"	1" NPT	241611616	9,13
1"	1"1/4" NPT	241612016	19,49
1"1/4"	1"1/4" NPT	241612020	16,74
1"1/2"	1"1/2" NPT	241612424	22,03
2"	2" NPT	241613232	37,85

Para aquellas mayores de 1" ver con junta // Pour ceux plus grand que 1" voir avec o'ring
// For those bigger than 1" see with o'ring // Per quelli più grandi di 1" vedere con o'ring

Conexiones Standard

Embouts serie Standard
Standard serie fittings
Raccordi serie Standard

Hoses

Macho rosca cilíndrica cono 60°



Embout mâle fixe gaz cyl BSP 60°
BSP Male parallel 60° cone
Maschio BSP cilindrico sede 60°

DN	ROSCA THREAD	REFERENCIA PART N°	€
3/16"	1/8" BSP	241120203	2,52
1/4"	1/8" BSP	241120204	1,79
1/8"	1/4" BSP	241120402	4,42
3/16"	1/4" BSP	241120403	3,26
1/4"	1/4" BSP	241120404	1,23
3/8"	1/4" BSP	241120406	2,57
1/4"	3/8" BSP	241120604	2,08
5/16"	3/8" BSP	241120605	1,84
3/8"	3/8" BSP	241120606	1,59
1/2"	3/8" BSP	241120608	2,42
1/4"	1/2" BSP	241120804	2,31
3/8"	1/2" BSP	241120806	2,02
1/2"	1/2" BSP	241120808	2,09
1/2"	5/8" BSP	241121008	5,57
5/8"	5/8" BSP	241121010	5,28
1/2"	3/4" BSP	241121208	4,74
5/8"	3/4" BSP	241121210	4,55
3/4"	3/4" BSP	241121212	3,73
3/4"	1" BSP	241121612	11,18
1"	1" BSP	241121616	6,49
1"	1"1/4 BSP	241122016	24,50
1"1/4	1"1/4 BSP	241122020	14,78
1"1/2	1"1/2 BSP	241122424	22,28
2"	2" BSP	241123232	40,09

Flexible hose fittings

Stainless steel hoses
and fittings

Low pressure

Air conditioned hoses
and fittings

Measuring flow

Machines for
mounting flexibles

Macho rosca cilíndrica asiento plano



Embout mâle fixe gaz cyl fond plat
BSP Male flat seat
Maschio BSP cilindrico sede piana

DN	ROSCA THREAD	REFERENCIA PART N°	€
1/4"	1/4" BSP	242120404	2,78
3/8"	3/8" BSP	242120606	4,10
3/8"	1/2" BSP	242120806	4,34
1/2"	1/2" BSP	242120808	4,78
3/4"	3/4" BSP	242121212	9,96

Orientable BSP

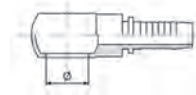

Embout Banjo droit gaz
Banjo BSP
Raccordo ad occhio BSP

DN	Ø	REFERENCIA PART N°	€
3/16"	1/4" BSP	241110403	2,54
1/4"	1/4" BSP	241110404	2,02
5/16"	1/4" BSP	241110405	2,62
3/8"	1/4" BSP	241110406	2,62
1/4"	3/8" BSP	241110604	2,73
5/16"	3/8" BSP	241110605	2,79
3/8"	3/8" BSP	241110606	2,62
1/2"	3/8" BSP	241110608	2,98
3/8"	1/2" BSP	241110806	4,69
1/2"	1/2" BSP	241110808	4,53
5/8"	5/8" BSP	241111010	20,70
1/2"	3/4" BSP	241111208	7,26
5/8"	3/4" BSP	241111210	13,88
3/4"	3/4" BSP	241111212	10,46
1"	1" BSP	241111616	27,87

Macho rosca cónica BSPT

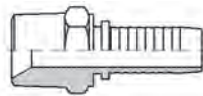

Embout mâle fixe gaz conique BSPT
BSPT Male tapered
Maschio BSPT conico

DN	ROSCA THREAD	REFERENCIA PART N°	€
3/16"	1/8" BSPT	241140203	2,75
1/4"	1/8" BSPT	241140204	2,03
1/4"	1/4" BSPT	241140404	2,12
1/4"	3/8" BSPT	241140604	3,49
5/16"	3/8" BSPT	241140605	2,90
3/8"	3/8" BSPT	241140606	2,26
3/8"	1/2" BSPT	241140806	2,76
1/2"	1/2" BSPT	241140808	3,05
5/8"	3/4" BSPT	241141210	9,66
3/4"	3/4" BSPT	241141212	4,54
3/4"	1" BSPT	241141612	12,63
1"	1" BSPT	241141616	11,24
1"	1"1/4 BSPT	241142016	22,45
1"1/4	1"1/4 BSPT	241142020	18,22
1"1/2	1"1/2 BSPT	241142424	22,03
2"	2" BSPT	241143232	41,94

Tornillo orientable simple BSP



Vis creuse simple pour banjo filetage gaz BSP
BSP bolt for Banjo
Bullone forato BSP

ROSCA THREAD	REFERENCIA PART N°	€
1/8" BSP	A109002	*
1/4" BSP	A109004	*
3/8" BSP	A109006	*
1/2" BSP	A109008	*
3/4" BSP	A109012	*
1" BSP	A109016	*
1" 1/4 BSP	A109020	*
1" 1/2 BSP	A109024	*

Ver precios en p.205 (ADAPTADORES BSP) / Prix à la p.205 (ADAPTEURS BSP) /
See prices in p.205 (BSP ADAPTORS) / Vedere prezzi p.205 (ADATTATORI BSP)

Conexiones Standard

Embouts serie Standard
Standard serie fittings
Raccordi serie Standard

Macho JIC 37°

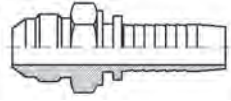

Embout mâle fixe JIC cone 37°
Male JIC 37° cone
Maschio JIC 37°

DN	ROSCA THREAD	REFERENCIA PART N°	€
1/4"	7/16" 20h UNF	241400704	1,76
1/4"	1/2" 20h UNF	241400804	2,02
1/4"	9/16" 18h UNF	241400904	1,93
5/16"	9/16" 18h UNF	241400905	1,78
3/8"	9/16" 18h UNF	241400906	1,55
3/8"	3/4" 16h UNF	241401206	2,09
1/2"	3/4" 16h UNF	241401208	2,28
3/8"	7/8" 14h UNF	241401406	3,58
1/2"	7/8" 14h UNF	241401408	2,77
5/8"	7/8" 14h UNF	241401410	3,15
1/2"	1"1/16 12h UNF	241401708	5,65
5/8"	1"1/16 12h UNF	241401710	3,76
3/4"	1"1/16 12h UNF	241401712	4,06
3/4"	1"5/16 12h UNF	241402112	7,07
1"	1"5/16 12h UNF	241402116	7,66
1"	1"5/8 12h UNF	241402616	13,64
1"1/4"	1"5/8 12h UNF	241402620	17,20
1"1/4"	1"7/8 12h UNF	241403020	25,84
1"1/2"	1"7/8 12h UNF	241403024	29,89
2"	2"1/2 12h UNF	241404032	44,05

Hembras giratorias rectas JIC 37°



Embout femelle tournant droit JIC cone 37°
JIC Swivel female 37° cone
Femmina diritta JIC 37°

DN	ROSCA THREAD	REFERENCIA PART N°	€
3/16"	7/16" 20h UNF	241420703	1,66
1/4"	7/16" 20h UNF	241420704	1,23
1/4"	1/2" 20h UNF	241420804	1,36
5/16"	1/2" 20h UNF	241420805	2,63
1/4"	9/16" 18h UNF	241420904	1,32
5/16"	9/16" 18h UNF	241420905	1,53
3/8"	9/16" 18h UNF	241420906	1,53
3/8"	5/8" 18h UNF	241421006	4,02
5/16"	3/4" 16h UNF	241421205	5,25
3/8"	3/4" 16h UNF	241421206	1,96
1/2"	3/4" 16h UNF	241421208	1,96
3/8"	7/8" 14h UNF	241421406	3,60
1/2"	7/8" 14h UNF	241421408	2,27
5/8"	7/8" 14h UNF	241421410	2,97
1/2"	1"1/16 12h UNF	241421708	5,82
5/8"	1"1/16 12h UNF	241421710	3,82
3/4"	1"1/16 12h UNF	241421712	3,82
1"	1"1/16 12h UNF	241421716	6,13
3/4"	1"5/16 12h UNF	241422112	6,13
1"	1"5/16 12h UNF	241422116	6,20
1"	1"5/8 12h UNF	241422616	16,00
1"1/4"	1"5/8 12h UNF	241422620	12,04
1"1/4"	1"7/8 12h UNF	241423020	31,99
1"1/2"	1"7/8 12h UNF	241423024	23,06
2"	2"1/2 12h UNF	241424032	34,25

Hembras giratorias 90° JIC 37°

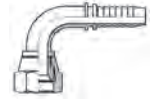

Embout coude 90° femelle tournant cone JIC 37°
90° JIC Swivel female 37° cone
Femmina a 90° JIC 37°

DN	ROSCA THREAD	REFERENCIA PART N°	€
3/16"	7/16" 20h UNF	241380703	4,07
1/4"	7/16" 20h UNF	241380704	1,80
1/4"	1/2" 20h UNF	241380804	3,01
1/4"	9/16" 18h UNF	241380904	2,48
5/16"	9/16" 18h UNF	241380905	3,30
3/8"	9/16" 18h UNF	241380906	2,67
3/8"	5/8" 18h UNF	241381006	7,95
3/8"	3/4" 16h UNF	241381206	3,24
1/2"	3/4" 16h UNF	241381208	3,39
3/8"	7/8" 14h UNF	241381406	6,91
1/2"	7/8" 14h UNF	241381408	4,51
5/8"	7/8" 14h UNF	241381410	6,95
1/2"	1"1/16 12h UNF	241381708	13,03
5/8"	1"1/16 12h UNF	241381710	9,18
3/4"	1"1/16 12h UNF	241381712	6,35
3/4"	1"5/16 12h UNF	241382112	13,41
1"	1"5/16 12h UNF	241382116	13,41
1"	1"5/8 12h UNF	241382616	36,65
1"1/4"	1"5/8 12h UNF	241382620	31,14
1"1/4"	1"7/8 12h UNF	241383020	54,12
1"1/2"	1"7/8 12h UNF	241383024	52,00
2"	2"1/2 12h UNF	241384032	108,26

Hembras giratorias 45° JIC 37°

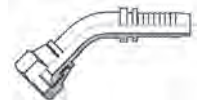

Embout coude 45° femelle tournant cone JIC 37°
45° JIC swivel female 37° cone
Femmina a 45° JIC 37°

DN	ROSCA THREAD	REFERENCIA PART N°	€
3/16"	7/16" 20h UNF	241390703	4,12
1/4"	7/16" 20h UNF	241390704	3,00
1/4"	1/2" 20h UNF	241390804	3,24
1/4"	9/16" 18h UNF	241390904	3,08
5/16"	9/16" 18h UNF	241390905	3,68
3/8"	9/16" 18h UNF	241390906	3,52
3/8"	3/4" 16h UNF	241391206	4,37
1/2"	3/4" 16h UNF	241391208	5,15
1/2"	7/8" 14h UNF	241391408	5,41
5/8"	7/8" 14h UNF	241391410	7,25
1/2"	1"1/16 12h UNF	241391708	13,78
5/8"	1"1/16 12h UNF	241391710	9,41
3/4"	1"1/16 12h UNF	241391712	9,41
3/4"	1"5/16 12h UNF	241392112	16,91
1"	1"5/16 12h UNF	241392116	15,30
1"	1"5/8 12h UNF	241392616	34,31
1"1/4"	1"5/8 12h UNF	241392620	33,43
1"1/4"	1"7/8 12h UNF	241393020	55,53
1"1/2"	1"7/8 12h UNF	241393024	56,48
2"	2"1/2 12h UNF	241394032	108,26

Conexiones Standard

Embouts serie Standard
Standard serie fittings
Raccordi serie Standard

Hoses

Flexible hose fittings

Stainless steel hoses and fittings

Low pressure

Air conditioned hoses and fittings

Measuring flow

Machines for mounting flexibles

Hembras giratorias Métricas cono 24° con junta tórica

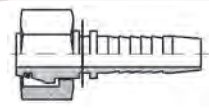

Embout femelle tournant droit Métrique cone 24° + o'ring Serie allemande
Metric swivel female 24° cone with o'ring
Femmina Metrica sede 24° con o'ring

DN	TUBO PIPE	SERIE	ROSCA THREAD	REFERENCIA PART N°	€
3/16"	6	L	12X1,5	24804120603	2,36
1/4"	6	L	12X1,5	24804120604	1,23
1/4"	8	L	14X1,5	24804140804	1,08
1/4"	10	L	16X1,5	24804161004	1,30
5/16"	10	L	16X1,5	24804161005	1,46
3/8"	10	L	16X1,5	24804161006	1,66
1/4"	12	L	18X1,5	24804181204	1,66
5/16"	12	L	18X1,5	24804181205	1,46
3/8"	12	L	18X1,5	24804181206	1,46
3/8"	15	L	22X1,5	24804221506	2,40
1/2"	15	L	22X1,5	24804221508	2,09
1/2"	18	L	26X1,5	24804261808	3,17
5/8"	18	L	26X1,5	24804261810	3,02
3/4"	22	L	30X2	24804302212	3,82
1"	28	L	36X2	24804362816	7,38
1" 1/4	35	L	45X2	24804453520	11,07
1" 1/2	42	L	52X2	24804524224	18,68
3/16"	8	S	16X1,5	24804160803	3,63
1/4"	8	S	16X1,5	24804160804	1,54
1/4"	10	S	18X1,5	24804181004	1,46
5/16"	12	S	20X1,5	24804201205	1,43
3/8"	12	S	20X1,5	24804201206	1,71
3/8"	14	S	22X1,5	24804221406	2,81
1/2"	16	S	24X1,5	24804241608	2,59
5/8"	20	S	30X2	24804302010	4,69
3/4"	20	S	30X2	24804302012	6,92
3/4"	25	S	36X2	24804362512	7,94
1"	25	S	36X2	24804362516	13,87
1"	30	S	42X2	24804423016	11,03
1" 1/4	38	S	52X2	24804523820	17,52

Hembras giratorias 90° Métricas cono 24° con junta tórica

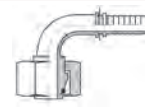

Embout coude 90° femelle tournant Métrique cone 24° + o'ring Serie allemande
90° Metric swivel female 24° cone with o'ring
Femmina Metrica a 90° sede 24° con o'ring

DN	TUBO PIPE	SERIE	ROSCA THREAD	REFERENCIA PART N°	€
3/16"	6	L	12X1,5	24305120603	4,64
1/4"	6	L	12X1,5	24305120604	2,02
1/4"	8	L	14X1,5	24305140804	2,24
1/4"	10	L	16X1,5	24305161004	2,38
5/16"	10	L	16X1,5	24305161005	2,11
3/8"	10	L	16X1,5	24305161006	2,26
5/16"	12	L	18X1,5	24305181205	2,74
3/8"	12	L	18X1,5	24305181206	2,57
3/8"	15	L	22X1,5	24305221506	6,02
1/2"	15	L	22X1,5	24305221508	3,49
5/8"	18	L	26X1,5	24305261810	4,81
3/4"	22	L	30X2	24305302212	7,08
1"	28	L	36X2	24305362816	14,28
1" 1/4	35	L	45X2	24305453520	24,16
1" 1/2	42	L	52X2	24305524224	48,72
1/4"	8	S	16X1,5	24305160804	3,26
1/4"	10	S	18X1,5	24305181004	3,90
5/16"	12	S	20X1,5	24305201205	4,00
3/8"	12	S	20X1,5	24305201206	2,42
3/8"	14	S	22X1,5	24305221406	5,17
1/2"	16	S	24X1,5	24305241608	4,14
5/8"	20	S	30X2	24305302010	7,79
3/4"	20	S	30X2	24305302012	10,46
3/4"	25	S	36X2	24305362512	13,56
1"	25	S	36X2	24305362516	23,52
1"	30	S	42X2	24305423016	23,06
1" 1/4	38	S	52X2	24305523820	40,48

Hembras giratorias 45° Métricas cono 24° con junta tórica

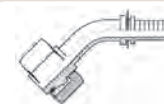

Embout coude 45° femelle tournant Métrique cone 24° + o'ring Serie allemande
45° Metric swivel female 24° cone with o'ring
Femmina Metrica a 45° sede 24° con o'ring

DN	TUBO PIPE	SERIE	ROSCA THREAD	REFERENCIA PART N°	€
1/4"	6	L	12X1,5	24306120604	5,23
1/4"	8	L	14X1,5	24306140804	2,47
1/4"	10	L	16X1,5	24306161004	2,40
5/16"	10	L	16X1,5	24306161005	3,21
3/8"	10	L	16X1,5	24306161006	6,12
5/16"	12	L	18X1,5	24306181205	4,29
3/8"	12	L	18X1,5	24306181206	3,25
1/2"	15	L	22X1,5	24306221508	4,61
5/8"	18	L	26X1,5	24306261810	7,40
3/4"	22	L	30X2	24306302212	9,64
1"	28	L	36X2	24306362816	19,03
1" 1/4	35	L	45X2	24306453520	31,14
1" 1/2	42	L	52X2	24306524224	43,21
1/4"	8	S	16X1,5	24306160804	3,76
1/4"	10	S	18X1,5	24306181004	5,00
5/16"	12	S	20X1,5	24306201205	4,24
3/8"	12	S	20X1,5	24306201206	4,24
3/8"	14	S	22X1,5	24306221406	5,41
1/2"	16	S	24X1,5	24306241608	5,63
5/8"	20	S	30X2	24306302010	10,42
3/4"	20	S	30X2	24306302012	14,12
3/4"	25	S	36X2	24306362512	15,38
1"	25	S	36X2	24306362516	24,01
1"	30	S	42X2	24306423016	23,52
1" 1/4	38	S	52X2	24306523820	40,48

Conexiones Standard

Embouts serie Standard
Standard serie fittings
Raccordi serie Standard

Machos Métricos cono 24°

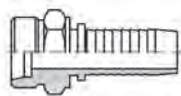

Embout mâle fixe Métrique cone 24°
Metric stud 24° cone
Maschio Metrico sede 24°

DN	TUBO PIPE	SERIE	ROSCA THREAD	REFERENCIA PART N°	€
3/16"	6	L	12X1,5	24203120603	2,60
1/4"	6	L	12X1,5	24203120604	1,78
1/4"	8	L	14X1,5	24203140804	1,45
1/4"	10	L	16X1,5	24203161004	1,93
5/16"	10	L	16X1,5	24203161005	1,61
3/8"	10	L	16X1,5	24203161006	1,78
1/4"	12	L	18X1,5	24203181204	2,76
5/16"	12	L	18X1,5	24203181205	2,29
3/8"	12	L	18X1,5	24203181206	1,63
3/8"	15	L	22X1,5	24203221506	2,07
1/2"	15	L	22X1,5	24203221508	2,14
1/2"	18	L	26X1,5	24203261808	4,59
5/8"	18	L	26X1,5	24203261810	3,44
3/4"	22	L	30X2	24203302212	4,79
1"	28	L	36X2	24203362816	8,93
1" 1/4	35	L	45X2	24203453520	14,35
1" 1/2	42	L	52X2	24203524224	22,87
1/4"	8	S	16X1,5	24203160804	2,39
1/4"	10	S	18X1,5	24203181004	2,42
5/16"	10	S	18X1,5	24203181005	2,83
3/8"	10	S	18X1,5	24203181006	3,39
5/16"	12	S	20X1,5	24203201205	2,34
3/8"	12	S	20X1,5	24203201206	1,94
3/8"	14	S	22X1,5	24203221406	2,57
1/2"	16	S	24X1,5	24203241608	2,76
5/8"	20	S	30X2	24203302010	4,54
3/4"	20	S	30X2	24203302012	5,88
3/4"	25	S	36X2	24203362512	7,07
1"	25	S	36X2	24203362516	9,88
1"	30	S	42X2	24203423016	13,17
1" 1/4	38	S	52X2	24203523820	21,18

Espiga lisa recta Métrica



Embout lisse droit Métrique
Metric standpipe
Estremità tubolare diritta Metrica

DN	TUBO PIPE	REFERENCIA PART N°	€
1/8"	6	241580602 L	2,51
3/16"	6	241580603 L	1,14
1/4"	6	241580604 L	1,04
3/16"	8	241580803 L	2,12
1/4"	8	241580804 L	1,19
5/16"	8	241580805 L	2,41
5/16"	10	241581005 L	1,21
3/8"	10	241581006 L	1,29
3/8"	12	241581206 L	1,17
1/2"	12	241581208 L	4,98
3/8"	15	241581506 L	2,37
1/2"	15	241581508 L	1,83
1/2"	18	241581808 L	2,32
5/8"	18	241581810 L	3,06
3/4"	22	241582212 L	3,19
1"	28	241582816 L	7,68
1" 1/4	35	241583520 L	13,13
1" 1/2	42	241584224 L	17,79
1/4"	8	241580804 S	1,31
1/4"	10	241581004 S	1,04
1/4"	12	241581204 S	1,95
5/16"	12	241581205 S	1,44
3/8"	14	241581406 S	1,61
1/2"	14	241581408 S	2,60
1/2"	16	241581608 S	2,00
5/8"	20	241582010 S	2,80
3/4"	20	241582012 S	3,48
3/4"	25	241582512 S	5,07
1"	25	241582516 S	9,25
1"	30	241583016 S	9,54
1" 1/4	38	241583820 S	12,91

Machos Stecko



Embout mâle fixe Stecko
Stecko male connections
Maschio Stecko

DN	STECKO	REFERENCIA PART N°	€
1/4"	1/4"	241900404	4,70
3/8"	3/8"	241900606	4,75
1/2"	1/2"	241900808	6,58
3/4"	3/4"	241901212	9,45

Espigas de prensar dobles



Embout double jonction
Double crimp standpipe
Giunzione tubo-tubo

DN	REFERENCIA PART N°	€
1/4"	243000404	2,04
5/16"	243000505	2,10
3/8"	243000606	2,34
1/2"	243000808	3,00
3/4"	243001212	10,08
1"	243001616	21,61

Conexiones Standard

Embouts serie Standard
Standard serie fittings
Raccordi serie Standard

Hoses

Espiga lisa a 90° Métrica



Embout lisse coude 90° Métrique
90° Metric standpipe
Estremitá tubolare a 90° Metrica

DN	TUBO PIPE	REFERENCIA PART N°	€
1/8"	6	242580602 L	*
3/16"	6	242580603 L	3,60
1/4"	6	242580604 L	3,31
3/16"	8	242580803 L	4,79
1/4"	8	242580804 L	3,61
3/8"	10	242581006 L	4,02
1/4"	12	242581204 L	4,94
3/8"	12	242581206 L	3,95
1/2"	15	242581508 L	6,15
1/2"	18	242581808 L	5,66
5/8"	18	242581810 L	7,55
5/8"	22	242582210 L	12,25
3/4"	22	242582212 L	9,22
1"	28	242582816 L	24,37
1 1/4"	35	242583520 L	32,19
1/4"	10	242581004 S	3,61
5/16"	12	242581205 S	4,88
3/8"	14	242581406 S	4,46
1/2"	14	242581408 S	6,49
1/2"	16	242581608 S	6,91
5/8"	20	242582010 S	13,56
3/4"	20	242582012 S	11,24
3/4"	25	242582512 S	13,81
1"	30	242583016 S	23,72

Flexible hose fittings

Stainless steel hoses
and fittings

Low pressure

Air conditioned hoses
and fittings

Measuring flow

Machines for
mounting flexibles

Espiga lisa a 45° Métrica

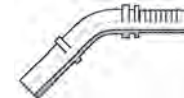

Embout lisse coude 45° Métrique
45° Metric standpipe
Estremitá tubolare a 45° Metrica

DN	TUBO PIPE	REFERENCIA PART N°	€
3/16"	6	243580603 L	6,68
1/4"	8	243580804 L	4,58
5/16"	10	243581005 L	5,18
3/8"	10	243581006 L	7,03
3/8"	12	243581206 L	4,64
1/2"	15	243581508 L	7,83
5/8"	18	243581810 L	10,80
3/4"	22	243582212 L	16,78
1/4"	10	243581004 S	3,90
5/16"	12	243581205 S	5,23
3/8"	14	243581406 S	10,57
1/2"	16	243581608 S	9,62
3/4"	20	243582012 S	13,53
3/4"	25	243582512 S	23,93

Tornillo orientable simple rosca Métrica

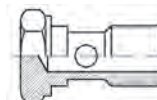

Vis creuse simple pour banjo filetage métrique
Metric bolt for Banjo
Bullone forato Metrico

ROSCA THREAD	REFERENCIA PART N°	€
M8x1	S109208	*
M10x1	S109210	*
M12x1.5	S109212	*
M14x1.5	S109214	*
M16x1.5	S109216	*
M18x1.5	S109218	*
M22x1.5	S109222	*
M26x1.5	S109226	*
M30x1.5	S109230	*

Ver precios en p.206 (ADAPTADORES BSP) / Prix à la p.206 (ADAPTEURS BSP) /
See prices in p.206 (BSP ADAPTORS) / Vedere prezzi p.206 (ADATTATORI BSP)

Orientable Métrico

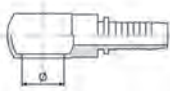

Embout Banjo droit Métrique
Banjo Metric
Raccordo ad occhio Metrico

DN	Ø	REFERENCIA PART N°	€
3/16"	M10X1	241161003	3,06
1/4"	M10X1	241161004	1,83
1/8"	M12X1	241161202	10,76
3/16"	M12X1.5	241161203	3,80
1/4"	M12X1.5	241161204	2,17
1/4"	M14X1.5	241161404	2,12
5/16"	M14X1.5	241161405	2,57
3/8"	M14X1.5	241161406	2,49
5/16"	M16X1.5	241161605	4,37
3/8"	M16X1.5	241161606	2,58
3/8"	M18X1.5	241161806	3,73
1/2"	M18X1.5	241161808	4,19
1/2"	M22X1.5	241162208	6,08
5/8"	M22X1.5	241162210	12,33
5/8"	M26X1.5	241162610	23,77
3/4"	M30X2	241163012	50,63

Hembras giratorias Métricas cono 24°/60°



Embout femelle tournant Métrique cono 24°-60°
Metric swivel female 24°/60° cone
Femmina Metrica Multiseal 24°/60°

DN	TUBO PIPE	ROSCA THREAD	REFERENCIA PART N°	€
1/4"	8L	M14X1.5	244049511	1,48
1/4"	10L	M16X1.5	244049520	1,93
5/16"	10L	M16X1.5	244049523	1,58
3/8"	10L	M16X1.5	244049524	2,17
5/16"	12L	M18X1.5	244049525	2,03
3/8"	12L	M18X1.5	244049535	1,69
3/8"	15L	M22X1.5	244049552	3,05
1/2"	15L	M22X1.5	244049555	2,43
5/8"	18L	M26X1.5	244049571	4,29

Conexiones Standard

Embouts serie Standard
Standard serie fittings
Raccordi serie Standard

Hembras giratorias 45° Métricas cono 24°/60°

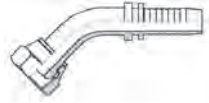

Embout femelle tournant coude 45° Métrique cone 24°-60°
45° Metric swivel female 24°/60° cone
Femmina Metrica a 45° Multiseal 24°/60°

DN	TUBO PIPE	ROSCA THREAD	REFERENCIA PART N°	€
1/4"	8L	M14X1.5	244069511	3,34
1/4"	10L	M16X1.5	244069520	4,91
5/16"	10L	M16X1.5	244069523	4,30
3/8"	10L	M16X1.5	244069524	5,86
5/16"	12L	M18X1.5	244069525	5,51
3/8"	12L	M18X1.5	244069535	3,69
3/8"	15L	M22X1.5	244069552	8,12
1/2"	15L	M22X1.5	244069555	5,05
5/8"	18L	M26X1.5	244069571	12,88

Hembras giratorias 90° Métricas cono 24°/60°

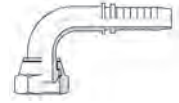

Embout femelle tournant coude 90° Métrique cone 24°-60°
90° Metric swivel female 24°/60° cone
Femmina Metrica a 90° Multiseal 24°/60°

DN	TUBO PIPE	ROSCA THREAD	REFERENCIA PART N°	€
1/4"	8L	M14X1.5	244059511	2,97
1/4"	10L	M16X1.5	244059520	4,20
5/16"	10L	M16X1.5	244059523	3,73
3/8"	10L	M16X1.5	244059524	5,86
5/16"	12L	M18X1.5	244059525	5,51
3/8"	12L	M18X1.5	244059535	3,81
3/8"	15L	M22X1.5	244059552	7,54
1/2"	15L	M22X1.5	244059555	5,42
5/8"	18L	M26X1.5	244059571	11,74

Hembras giratorias rectas Komatsu cono 60°



Embout femelle tournant droit Komatsu Métrique (cono 60°)
Komatsu swivel female 60° cone
Femmina Komatsu sede 60°

DN	ROSCA THREAD	REFERENCIA PART N°	€
1/4"	M14X1.5	258049625	4,34
3/8"	M18X1.5	258049635	4,74
1/2"	M22X1.5	258049655	7,52
5/8"	M24X1.5	258049665	11,51
3/4"	M30X1.5	258049684	15,10
1"	M33X1.5	258049685	23,86

Macho Métrico cono 24° serie francesa

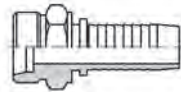

Embout mâle fixe gaz Serie Française Métrique 24°
Metric stud 24° cone French Serie
Maschio Metrico sede 24°

DN	TUBO PIPE	ROSCA THREAD	REFERENCIA PART N°	€
1/4"	13.2	M20X1.5	245032013204	1,55
5/16"	13.2	M20X1.5	245032013205	1,27
3/8"	13.2	M20X1.5	245032013206	1,27
5/16"	16.7	M24X1.5	245032416705	1,74
3/8"	16.7	M24X1.5	245032416706	1,50
1/2"	16.7	M24X1.5	245032416708	1,60
5/8"	21.2	M30X1.5	245033021210	27,70
3/4"	21.2	M30X1.5	245033021212	9,17
3/4"	26.7	M36X1.5	245033626712	31,48
1"	33.5	M45X1.5	245034533516	26,29

Macho Métrico válvula agrícola



Embout mâle fixe gaz Métrique pour valve agricole
Metric stud for agricultural valve
Maschio Metrico per valvola agricola

DN	ROSCA THREAD	REFERENCIA PART N°	€
1/4"	M18X1.5	245051804	3,29
5/16"	M18X1.5	245051805	3,29
3/8"	M18X1.5	245051806	3,29

Conexiones Standard

Embouts serie Standard
Standard serie fittings
Raccordi serie Standard

Hoses

Hembra giratoria recta Métrica cono 24° serie francesa

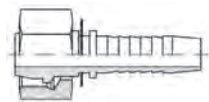

Embout femelle tournant gaz Serie Française Métrique 24°
Metric swivel female 24° cone French Serie
Femmina Metrica sede 24°

DN	TUBO PIPE	ROSCA THREAD	REFERENCIA PART N°	€
1/4"	13.2	M20X1.5	245042013204	1,79
5/16"	13.2	M20X1.5	245042013205	1,74
3/8"	13.2	M20X1.5	245042013206	3,59
5/16"	16.7	M24X1.5	245042416705	2,59
3/8"	16.7	M24X1.5	245042416706	2,59
1/2"	16.7	M24X1.5	245042416708	5,34

Hembra giratoria Métrica 90° cono 24° serie francesa

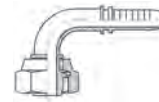

Embout femelle tournant gaz coude 90° Serie Française Métrique 24°
90° Metric swivel female 24° cone French Serie
Femmina Metrica a 90° sede 24°

DN	TUBO PIPE	ROSCA THREAD	REFERENCIA PART N°	€
5/16"	13.2	M20X1.5	245052013205	7,81
3/8"	13.2	M20X1.5	245052013206	10,24
1/2"	16.7	M24X1.5	245052416708	15,14
5/8"	21.2	M30X1.5	245053021210	24,05
3/4"	26.7	M36X1.5	245052673612	29,89

Flexible hose fittings

Bridas SAE partidas (semibridas)

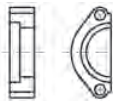

Demi-brides rectangulaires de fixation SAE
3000/6000 PSI SAE Split flanges
Semiflangia SAE 3000/6000 PSI

SERIE	TAMAÑO SIZE	REFERENCIA PART N°	€
3000 PSI	1/2"	AFS301	5,41
3000 PSI	3/4"	AFS302	5,38
3000 PSI	1"	AFS303	5,57
3000 PSI	1"1/4	AFS304	6,83
3000 PSI	1"1/2	AFS305	9,59
3000 PSI	2"	AFS306	11,95
3000 PSI	2"1/2	AFS307	26,46
3000 PSI	3"	AFS308	46,88
3000 PSI	3"1/2	AFS309	72,80
3000 PSI	4"	AFS310	91,93
3000 PSI	5"	AFS311	115,38
6000 PSI	1/2"	AFS601	6,97
6000 PSI	3/4"	AFS602	6,45
6000 PSI	1"	AFS603	9,80
6000 PSI	1"1/4	AFS604	19,41
6000 PSI	1"1/2	AFS605	24,48
6000 PSI	2"	AFS606	36,43

Bridas SAE enteras (monoblock)

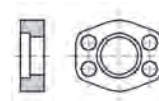

Brides monobloc rectangulaires de fixation SAE
3000/6000 PSI SAE Flanges
Flangia SAE 3000/6000 PSI

SERIE	TAMAÑO SIZE	REFERENCIA PART N°	€
3000 PSI	1/2"	AFSI301	3,97
3000 PSI	3/4"	AFSI302	5,19
3000 PSI	1"	AFSI303	5,91
3000 PSI	1"1/4	AFSI304	7,43
3000 PSI	1"1/2	AFSI305	10,02
3000 PSI	2"	AFSI306	13,12
3000 PSI	2"1/2	AFSI307	24,54
3000 PSI	3"	AFSI308	38,96
3000 PSI	3"1/2	AFSI309	72,80
3000 PSI	4"	AFSI310	91,93
3000 PSI	5"	AFSI311	115,38
6000 PSI	1/2"	AFSI601	4,40
6000 PSI	3/4"	AFSI602	7,14
6000 PSI	1"	AFSI603	10,89
6000 PSI	1"1/4	AFSI604	14,49
6000 PSI	1"1/2	AFSI605	23,94
6000 PSI	2"	AFSI606	37,64

Stainless steel hoses
and fittings

Low pressure

Air conditioned hoses
and fittings

Measuring flow

Machines for
mounting flexibles

Conexiones Standard

Embouts serie Standard
Standard serie fittings
Raccordi serie Standard

Brida recta SAE 3000 PSI

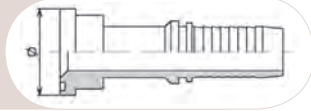

Embout bride SAE droite serie 3000 PSI
3000 PSI SAE Straight flange
Flangia diritta SAE 3000 PSI

DN	Ø	REFERENCIA PART N°	€
1/2"	30.2	241820808	9,71
1/2"	38.1	241821208	13,98
5/8"	38.1	241821210	19,06
3/4"	38.1	241821212	11,20
3/4"	44.5	241821612	15,24
1"	44.5	241821616	15,51
1"	50.8	241822016	21,61
1 1/4"	50.8	241822020	20,33
1 1/4"	60.3	241822420	30,50
1 1/2"	60.3	241822424	25,07
1 1/2"	71.4	241823224	51,68
2"	71.4	241823232	48,72

Brida recta SAE 6000 PSI

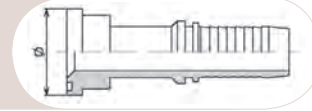

Embout bride SAE droite serie 6000 PSI
6000 PSI SAE Straight flange
Flangia diritta SAE 6000 PSI

DN	Ø	REFERENCIA PART N°	€
1/2"	31.8	242820808	11,95
1/2"	41.3	242821208	17,37
5/8"	41.3	242821210	20,33
3/4"	41.3	242821212	14,62
3/4"	47.6	242821612	18,22
1"	47.6	242821616	19,35
1"	54	242822016	24,99
1 1/4"	54	242822020	24,15
1 1/4"	63.5	242822420	36,43
1 1/2"	63.5	242822424	41,09
1 1/2"	79.4	242823224	78,37
2"	79.4	242823232	62,86

Brida a 90° SAE 3000 PSI

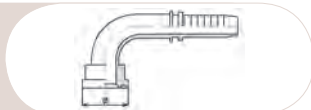

Embout bride SAE coude 90° serie 3000 PSI
3000 PSI SAE 90° Flange
Flangia a 90° SAE 3000 PSI

DN	Ø	REFERENCIA PART N°	€
1/2"	30.2	241830808	12,64
1/2"	38.1	241831208	19,06
5/8"	38.1	241831210	22,87
3/4"	38.1	241831212	15,55
3/4"	44.5	241831612	18,64
1"	44.5	241831616	22,11
1"	50.8	241832016	32,82
1 1/4"	50.8	241832020	30,35
1 1/4"	60.3	241832420	51,68
1 1/2"	60.3	241832424	52,95
1 1/2"	71.4	241833224	95,70
2"	71.4	241833232	94,88

Brida a 90° SAE 6000 PSI

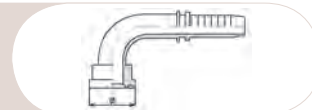

Embout bride SAE coude 90° serie 6000 PSI
6000 PSI SAE 90° Flange
Flangia a 90° SAE 6000 PSI

DN	Ø	REFERENCIA PART N°	€
1/2"	31.8	242830808	13,74
1/2"	41.3	242831208	22,03
5/8"	41.3	242831210	25,08
3/4"	41.3	242831212	17,18
3/4"	47.6	242831612	22,87
1"	47.6	242831616	24,87
1"	54	242832016	37,11
1 1/4"	54	242832020	37,70
1 1/4"	63.5	242832420	66,93
1 1/2"	63.5	242832424	71,59
1 1/2"	79.4	242833224	132,16
2"	Ø 79.4	242833232	*

Brida a 45° SAE 3000 PSI

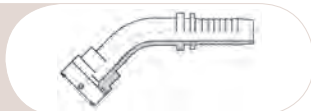

Embout bride SAE coude 45° serie 3000 PSI
3000 PSI SAE 45° Flange
Flangia a 45° SAE 3000 PSI

DN	Ø	REFERENCIA PART N°	€
1/2"	30.2	241840808	14,40
1/2"	38.1	241841208	19,91
5/8"	38.1	241841210	30,50
3/4"	38.1	241841212	15,25
3/4"	44.5	241841612	18,86
1"	44.5	241841616	19,91
1"	50.8	241842016	27,54
1 1/4"	50.8	241842020	29,87
1 1/4"	60.3	241842420	46,82
1 1/2"	60.3	241842424	49,14
1 1/2"	71.4	241843224	91,07
2"	71.4	241843232	88,95

Brida a 45° SAE 6000 PSI

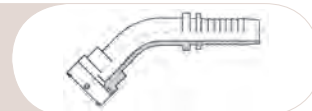

Embout bride SAE coude 45° serie 6000 PSI
6000 PSI SAE 45° Flange
Flangia a 45° SAE 6000 PSI

DN	Ø	REFERENCIA PART N°	€
1/2"	31.8	242840808	15,25
1/2"	41.3	242841208	22,03
5/8"	41.3	242841210	33,04
3/4"	41.3	242841212	17,25
3/4"	47.6	242841612	23,11
1"	47.6	242841616	22,45
1"	54	242842016	35,16
1 1/4"	54	242842020	38,21
1 1/4"	63.5	242842420	61,59
1 1/2"	63.5	242842424	69,62
1 1/2"	79.4	242843224	131,69
2"	79.4	242843232	122,84

Conexiones Standard

Embouts serie Standard
Standard serie fittings
Raccordi serie Standard

Hoses

Flexible hose fittings

Brida recta Caterpillar 9000 PSI

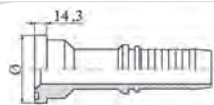

Embout bride tournante droite Caterpillar serie 9000 PSI
9000 PSI Caterpillar straight Flange
Flangia diritta Caterpillar

DN	Ø	REFERENCIA PART N°	€
3/4"	41.3	442821212	18,47
3/4"	47.6	442821612	23,94
1"	47.6	442821616	24,11
1"	54	442822016	35,92
1"1/4	54	442822020	35,92
1"1/2	63.5	442822424	52,82

Brida a 90° Caterpillar 9000 PSI

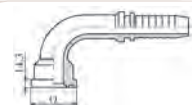

Embout bride tournante coude 90° Caterpillar serie 9000 PSI
9000 PSI Caterpillar 90° Flange
Flangia a 90° Caterpillar

DN	Ø	REFERENCIA PART N°	€
3/4"	41.3	442831212	26,82
3/4"	47.6	442831612	40,99
1"	47.6	442831616	34,62
1"	54	442832016	47,36
1"1/4	54	442832020	54,65
1"1/2	63.5	442832424	79,48

Brida a 45° Caterpillar 9000 PSI

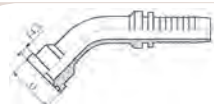

Embout bride tournante coude 45° Caterpillar serie 9000 PSI
9000 PSI Caterpillar 45° Flange
Flangia a 45° Caterpillar

DN	Ø	REFERENCIA PART N°	€
3/4"	41.3	442841212	26,82
3/4"	47.6	442841612	40,99
1"	47.6	442841616	35,31
1"	54	442842016	53,17
1"1/4	54	442842020	54,07
1"1/2	63.5	442842424	75,99

Stainless steel hoses and fittings

Low pressure

Junta tórica para brida SAE



O'rings pour bride serie 3000/6000 PSI
O'rings for 3000/6000 PSI SAE flanges
O'rings per flange SAE

Ø int	REFERENCIA PART N°	€
23.39	23.39X3.53	0,22
31.34	31.34X3.53	0,28
36.09	36.09X3.53	0,33
46.04	46.04X3.53	0,44
55.56	55.56X3.53	0,48

Air conditioned hoses and fittings

Measuring flow

Juntas para bridas



Jointes pour bride serie 3000/6000
Seals for 3000/6000 PSI flange
Guarnizioni per flange SAE 3000/6000 PSI

Ø ext	Ø int	REFERENCIA PART N°	€
25.40	17.02	JBR08	2,87
31.72	23.36	JBR12	2,97
39.62	31.24	JBR16	3,10
44.45	36.07	JBR20	3,65
53.98	45.34	JBR24	3,85
63.50	54.86	JBR32	4,03

Machines for mounting flexibles

Conexiones Standard

Embouts serie Standard
Standard serie fittings
Raccordi serie Standard

Espiga para brida macho Poclair

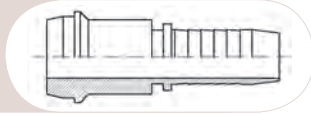

Embout bride mâle Poclair
Poclair male flange
Inserto per flangia maschio Poclair

DN	Ø	REFERENCIA PART N°	€
1/2"	1/2"	448010808	9,31
5/8"	5/8"	448011010	11,09
3/4"	3/4"	448011212	14,81
1"	1"	448011616	18,19
1"1/4	1"1/4	448012020	23,78

Espiga para brida hembra Poclair

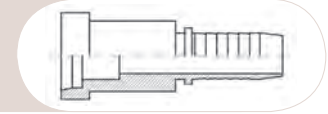

Embout bride femelle Poclair
Poclair female flange
Inserto per flangia femmina Poclair

DN	Ø	REFERENCIA PART N°	€
1/2"	1/2"	448020808	9,31
5/8"	5/8"	448021010	11,09
3/4"	3/4"	448021212	14,81
1"	1"	448021616	18,19
1"1/4	1"1/4	448022020	23,78

Espiga a 90° brida macho Poclair

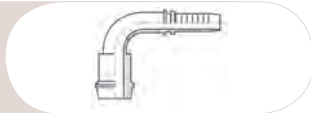

Embout bride coude 90° macho Poclair
90° Poclair female flange standpipe
Inserto per flangia a 90° Poclair

DN	Ø	REFERENCIA PART N°	€
1/2"	1/2"	448030808	17,11
3/4"	3/4"	448031212	27,03
1"1/4	1"1/4	448032020	47,24

Brida entera macho Poclair 4 agujeros

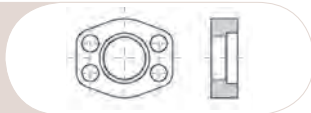

Bride rectangulaire de fixation mâle Poclair-4 trous
Male Poclair flange 4 holes
Flangia intera maschio Poclair 4 fori

TUBO PIPE	REFERENCIA PART N°	€
1/2"	448050808	12,80
5/8"	448051010	13,30
3/4"	448051212	15,50
1"	448051616	18,90
1"1/4	448052020	28,70

Brida entera hembra Poclair 4 agujeros

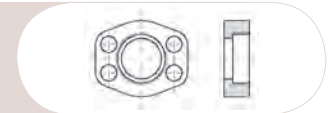

Bride rectangulaire de fixation femelle Poclair 4 trous
Female Poclair flange 4 holes
Flangia intera femmina Poclair 4 fori

TUBO PIPE	REFERENCIA PART N°	€
1/2"	448060808	12,80
5/8"	448061010	13,30
3/4"	448061212	15,50
1"	448061616	18,90
1"1/4	448062020	28,70

Brida entera macho Poclair 2 agujeros

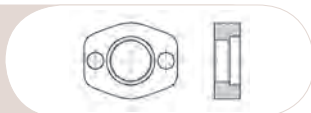

Bride oval fixation mâle Poclair 2 trous
Male Poclair flange 2 holes
Flangia intera maschio Poclair 2 fori

TUBO PIPE	REFERENCIA PART N°	€
1/2"	448070808	18,50
5/8"	448071010	19,21
3/4"	448071212	22,65
1"	448071616	24,80
1"1/4	448072020	39,50

Brida entera hembra Poclair 2 agujeros

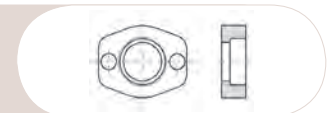

Bride oval fixation femelle Poclair 2 trous
Female Poclair flange 2 holes
Flangia intera femmina Poclair 2 fori

TUBO PIPE	REFERENCIA PART N°	€
1/2"	448080808	15,10
5/8"	448081010	15,30
3/4"	448081212	26,15
1"	448081616	19,35
1"1/4	448082020	21,05

Conexiones Standard

Embouts serie Standard
Standard serie fittings
Raccordi serie Standard

Hoses

Flexible hose fittings

Stainless steel hoses and fittings

Low pressure

Air conditioned hoses and fittings

Measuring flow

Machines for mounting flexibles

Hembra giratoria recta ORFS asiento plano

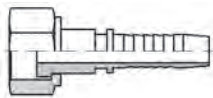

Embout femelle tournant serie Caterpillar-ORFS fond plat
ORFS Swivel female straight flat seat
Femmina diritta sede piana ORFS

DN	ROSCA THREAD	REFERENCIA PART N°	€
1/4"	9/16" 18h UNF	449000404	2,54
1/4"	11/16" 16h UNF	449000604	3,78
5/16"	11/16" 16h UNF	449000605	3,90
3/8"	11/16" 16h UNF	449000606	3,19
3/8"	13/16" 16h UNF	449000806	4,58
1/2"	13/16" 16h UNF	449000808	3,52
1/2"	1" 14h UNF	449001008	5,73
5/8"	1" 14h UNF	449001010	5,93
1/2"	1" 3/16 12h UNF	449001208	12,67
3/4"	1" 3/16 12h UNF	449001212	8,05
3/4"	1" 7/16 12h UNF	449001612	18,73
1"	1" 7/16 12h UNF	449001616	16,94
1"1/4	1"11/16 12h UNF	449002020	22,45
1"1/2	2" 12h UNF	449002424	37,70

Hembra giratoria 90° ORFS asiento plano

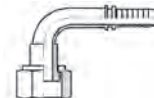

Embout femelle tournant coude 90° serie Caterpillar-ORFS fond plat
90° ORFS Swivel female flat seat
Femmina a 90° sede piana ORFS

DN	ROSCA THREAD	REFERENCIA PART N°	€
1/4"	9/16" 18h UNF	449070404	5,05
5/16"	11/16" 16h UNF	449070605	7,54
3/8"	11/16" 16h UNF	449070606	4,36
3/8"	13/16" 16h UNF	449070806	7,12
1/2"	13/16" 16h UNF	449070808	6,02
1/2"	1-14h UNF	449071008	14,40
5/8"	1" 14h UNF	449071010	11,86
1/2"	1 3/16-12h UNF	449071208	22,09
3/4"	1" 3/16 12h UNF	449071212	14,46
3/4"	1" 7/16 12h UNF	449071612	25,57
1"	1" 7/16 12h UNF	449071616	26,26
1"1/4	1"11/16 12h UNF	449072020	41,09
1"1/2	2" 12h UNF	449072424	63,96

Machos ORFS asiento plano con junta tórica

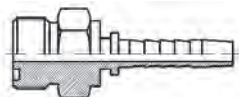

Embout mâle fixe serie Caterpillar-ORFS fond plat + o'ring
ORFS Male flat seat + o'ring
Maschio ORFS sede piana con o'ring

DN	ROSCA THREAD	REFERENCIA PART N°	€
1/4"	9/16" 18h UNF	449120404	5,65
1/4"	11/16" 16h UNF	449120604	7,55
5/16"	11/16" 16h UNF	449120605	10,47
3/8"	11/16" 16h UNF	449120606	5,73
1/2"	13/16" 16h UNF	449120808	5,92
5/8"	1" 14h UNF	449121010	9,63
3/4"	1" 3/16 12h UNF	449121212	13,52
1"	1" 7/16 12h UNF	449121616	22,45
1"1/4	1"11/16-12h UNF	449122020	24,99

Hembra giratoria 45° ORFS asiento plano

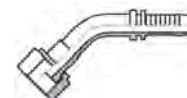

Embout femelle tournant coude 45° serie Caterpillar-ORFS fond plat
45° ORFS Swivel female
Femmina a 45° sede piana ORFS

DN	ROSCA THREAD	REFERENCIA PART N°	€
1/4"	9/16" 18h UNF	449080404	4,74
3/8"	11/16" 16h UNF	449080606	4,83
3/8"	13/16" 16h UNF	449080806	7,76
1/2"	13/16" 16h UNF	449080808	6,15
1/2"	1" - 14h UNF	449081008	12,63
5/8"	1" 14h UNF	449081010	11,86
3/4"	1" 3/16 12h UNF	449081212	14,79
1"	1" 7/16 12h UNF	449081616	25,84
1"1/4	1"11/16 12h UNF	449082020	41,09
1"1/2	2" 12h UNF	449082424	63,12

Juntas tóricas para ORFS



O'ring para ORFS
O'ring for ORFS
O'ring per raccordi ORFS

Ø int	REFERENCIA PART N°	€
9.25	9.25X1.78	0,05
7.65	7.65X1.78	0,05
12.42	12.42X1.78	0,06
15.60	15.60X1.78	0,07
18.77	18.77X1.78	0,09
23.52	23.52X1.78	0,11
29.87	29.87X1.78	0,15
37.82	37.82X1.78	0,20

Conexiones Standard

Embouts serie Standard
Standard serie fittings
Raccordi serie Standard

Macho pistola hidrolavadora

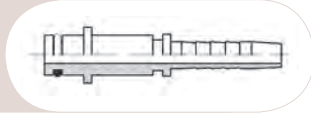

Embout mâle fixe spécial pistolet-hydroneettoyage
Male terminal steel hydro-wash
Maschio pistola idropulitrice

DN	REFERENCIA PART N°	€
1/4"	230400400	2,71

Empuñaduras de goma negras



Poignée hydroneettoyage de gomme noir
Handle with black rubber
Manopola di gomma nera

DN	REFERENCIA PART N°	€
1/4"	230600400	1,27
5/16"	230600500	1,62
3/8"	230600600	1,47

Empuñaduras de goma grises



Poignée hydroneettoyage de gomme gris
Handle with grey rubber
Manopola di gomma grigia

DN	REFERENCIA PART N°	€
1/4"	230610400	1,93
5/16"	230610500	2,49
3/8"	230610600	2,18

Terminal Karcher acero

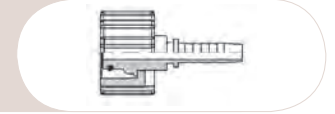

Embout femelle tournant acier speciaux hydroneettoyage
Swivel female steel hydro-wash
Femmina in acciaio per idropultrici

TUBO PIPE	ROSCA THREAD	REFERENCIA PART N°	€
1/4	M22X1.5	230700400	3,60
5/16	M22X1.5	230700500	3,66
3/8	M22X1.5	230700600	4,69

Empuñaduras de goma azules



Poignées hydroneettoyage de gomme bleu
Handle with blue rubber
Manopola di gomma azzurra

DN	REFERENCIA PART N°	€
5/16"	230620500	2,49
3/8"	230620600	2,18

Conexiones Interlock

Embouts à sertir Interlock
Interlock serie fittings
Raccordi serie Interlock

Hoses

Casquillos 4SH



Jupe à sertir DIN 20023 4SH
Ferrules DIN 20023-4SH
Boccola Interlock 4SH

DN	REFERENCIA PART N°	€
3/4"	A610101200	5,41
1"	A610101600	9,73
1"1/4	A610102000	15,86
1"1/2	A610102400	24,21
2"	A610103200	43,78

Casquillos R13-R15



Jupe à sertir DIN 20023 R13/R15
Ferrules SAE 100 R13/R15
Boccola Interlock R13/R15

DN	REFERENCIA PART N°	€
1"1/4	610102000	18,03
1"1/2	610102400	30,90
2"	610103200	43,78

Flexible hose fittings

Stainless steel hoses
and fittings

Hembras giratorias rectas BSP cono 60°



Embout femelle tournant gaz cyl BSP 60° + o'ring
BSP Swivel female 60° cone
Femmina diritta BSP sede 60° con o'ring

DN	ROSCA THREAD	REFERENCIA PART N°	€
3/4"	3/4" BSP	641001212	12,88
1"	1" BSP	641001616	17,51
1"1/4	1"1/4 BSP	641002020	28,33
1"1/2	1"1/2 BSP	641002424	36,57
2"	2" BSP	641003232	72,10

Macho rosca cilíndrica BSP cono 60°

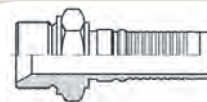

Embout mâle fixe gaz cyl BSP 60°
BSP Male 60° cone
Maschio cilindrico BSP sede 60°

DN	ROSCA THREAD	REFERENCIA PART N°	€
3/4"	3/4" BSP	641121212	14,42
1"	1" BSP	641121616	19,83
1"1/4	1"1/4 BSP	641122020	30,64
1"1/2	1"1/2 BSP	641122424	36,05
2"	2" BSP	641123232	74,36

Low pressure

Air conditioned hoses
and fittings

Hembras giratorias 90° BSP cono 60°

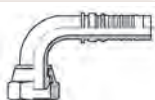

Embout femelle tournant coude 90° gaz cyl BSP 60° + o'ring
90° BSP Swivel female 60° cone
Femmina a 90° BSP sede 60° con o'ring

DN	ROSCA THREAD	REFERENCIA PART N°	€
3/4"	3/4" BSP	641071212	22,15
1"	1" BSP	641071616	29,87
1"1/4	1"1/4 BSP	641072020	47,38
1"1/2	1"1/2 BSP	641072424	82,47
2"	2" BSP	641073232	149,68

Macho rosca NPT



Embout mâle fixe NPT
NPT Male thread
Maschio conico NPT

DN	ROSCA THREAD	REFERENCIA PART N°	€
3/4"	3/4" NPT	641611212	14,42
1"	1" NPT	641611616	18,93
1"1/4	1"1/4 NPT	641612020	27,49
1"1/2	1"1/2 NPT	641612424	33,35
2"	2" NPT	641613232	59,48

Measuring flow

Hembras giratorias 45° BSP cono 60°



Embout femelle tournant coude 45° gaz cyl BSP 60° + o'ring
45° BSP Swivel female 60° cone
Femmina a 45° BSP sede 60° con o'ring

DN	ROSCA THREAD	REFERENCIA PART N°	€
3/4"	3/4" BSP	641081212	23,18
1"	1" BSP	641081616	30,90
1"1/4	1"1/4 BSP	641082020	46,35
1"1/2	1"1/2 BSP	641082424	77,96
2"	2" BSP	641083232	162,23

Machines for
mounting flexibles

Conexiones Interlock

Embouts à sertir Interlock
Interlock serie fittings
Raccordi serie Interlock

Hembras giratorias rectas JIC 37°

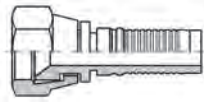

Embout femelle tournant JIC 37°
JIC 37° Swivel female
Femmina diritta JIC 37°

DN	ROSCA THREAD	REFERENCIA PART N°	€
3/4"	1"1/16 12h UNF	641421712	14,42
1"	1"5/16 12h UNF	641422116	20,09
1"1/4	1"5/8 12h UNF	641422620	27,81
1"1/2	1"7/8 12h UNF	641423024	41,26
2"	2"1/2 12h UNF	641424032	72,86

Hembras giratorias 90° JIC 37° con junta tórica

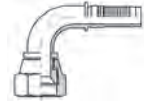

Embout femelle tournant coude 90° JIC 37°
90° JIC 37° Swivel female
Femmina a 90° JIC 37°

DN	ROSCA THREAD	REFERENCIA PART N°	€
3/4"	1"1/16 12h UNF	641381712	24,21
1"	1"5/16 12h UNF	641382116	35,54
1"1/4	1"5/8 12h UNF	641382620	50,47
1"1/2	1"7/8 12h UNF	641383024	92,27
2"	2"1/2 12h UNF	641384032	163,29

Hembras giratorias 45° JIC 37° con junta tórica



Embout femelle tournant coude 45° JIC 37°
45° JIC 37° Swivel female
Femmina a 45° JIC 37°

DN	ROSCA THREAD	REFERENCIA PART N°	€
3/4"	1"1/16 12h UNF	641391712	27,49
1"	1"5/16 12h UNF	641392116	34,25
1"1/4	1"5/8 12h UNF	641392620	55,34
1"1/2	1"7/8 12h UNF	641393024	92,27
2"	2"1/2 12h UNF	641394032	163,29

Macho JIC 37°



Embout mâle fixe JIC 37°
JIC 37° male
Maschio JIC 37°

DN	ROSCA THREAD	REFERENCIA PART N°	€
3/4"	1"1/16 12h UNF	641401712	11,77
1"	1"5/16 12h UNF	641402116	19,38
1"1/4	1"5/8 12h UNF	641402620	29,29
1"1/2	1"7/8 12h UNF	641403024	35,67
2"	2"1/2 12h UNF	641404032	65,79

Hembra giratoria recta Métrica cono 24° con junta tórica

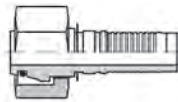

Embout femelle tournante Métrique 24° + o'ring
Metric swivel female 24°seat with o'ring
Femmina Metrica sede 24° con o'ring

DN	TUBO PIPE	SERIE	ROSCA THREAD	REFERENCIA PART N°	€
3/4"	20	S	M30X2	64204302012	16,48
3/4"	25	S	M36X2	64204362512	17,00
1"	30	S	M42X2	64204423016	19,06
1"1/4	38	S	M52X2	64204523820	28,33

Hembra giratoria 90° Métrica cono 24° con junta tórica

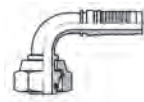

Embout femelle tournante coude 90° Métrique + o'ring
90° Metric swivel female 24°seat with o'ring
Femmina a 90° Metrica sede 24° con o'ring

DN	TUBO PIPE	SERIE	ROSCA THREAD	REFERENCIA PART N°	€
3/4"	20	S	M30X2	64205302012	27,30
3/4"	25	S	M36X2	64205362512	25,24
1"	30	S	M42X2	64205423016	32,45
1"1/4	38	S	M52X2	64205523820	47,90

Hembra giratoria 45° Métrica cono 24° con junta tórica



Embout femelle tournante coude 45° Métrique + o'ring
45° Metric swivel female 24°seat with o'ring
Femmina a 45° sede 24° con o'ring

DN	TUBO PIPE	SERIE	ROSCA THREAD	REFERENCIA PART N°	€
3/4"	20	S	M30X2	64206302012	27,30
3/4"	25	S	M36X2	64206362512	25,24
1"	30	S	M42X2	64206423016	33,99
1"1/4	38	S	M52X2	64206523820	47,90

Macho rosca Métrica cono 24° con junta tórica



Embout mâle fixe Métrique 24° serie lourde
Metric male stud 24° cone
Maschio Metrico sede 24°

DN	TUBO PIPE	SERIE	ROSCA THREAD	REFERENCIA PART N°	€
3/4"	20	S	M30X2	64203302012	15,34
3/4"	25	S	M36X2	64203362512	17,22
1"	30	S	M42X2	64203423016	22,53
1"1/4	38	S	M52X2	64203523820	31,54

Conexiones Interlock

Embouts à sertir Interlock
Interlock serie fittings
Raccordi serie Interlock

Hoses

Flexible hose fittings

Stainless steel hoses and fittings

Low pressure

Air conditioned hoses and fittings

Measuring flow

Machines for mounting flexibles

Brida SAE 3000 PSI



Embout bride SAE droite série 3000 PSI
3000 PSI SAE Straight flange
Flangia SAE 3000 PSI

DN	Ø	REFERENCIA PART N°	€
3/4"	38.1	641821212	15,45
3/4"	44.5	641821612	23,89
1"	44.5	641821616	20,60
1"	50.8	641822016	31,10
1"1/4	50.8	641822020	29,87
1"1/4	60.3	641822420	41,91
1"1/2	60.3	641822424	42,23
1"1/2	71.4	641823224	72,10
2"	71.4	641823232	61,80

Brida SAE 6000 PSI



Embout bride SAE droite série 6000 PSI
6000 PSI SAE Straight flange
Flangia SAE 6000 PSI

DN	Ø	REFERENCIA PART N°	€
3/4"	41.3	642821212	16,48
3/4"	47.6	642821612	21,63
1"	47.6	642821616	23,18
1"	54	642822016	30,39
1"1/4	54	642822020	30,90
1"1/4	63.5	642822420	47,90
1"1/2	63.5	642822424	44,29
1"1/2	79.4	642823224	85,17
2"	79.4	642823232	90,13

Brida a 90° SAE 3000 PSI

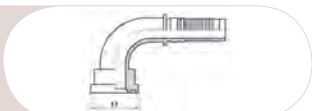

Embout bride SAE coude 90° série 3000 PSI
90° 3000 PSI SAE Flange
Flangia a 90° SAE 3000 PSI

DN	Ø	REFERENCIA PART N°	€
3/4"	38.1	641831212	24,33
3/4"	44.5	641831612	32,23
1"	44.5	641831616	32,23
1"	50.8	641832016	41,01
1"1/4	50.8	641832020	48,67
1"1/4	60.3	641832420	67,59
1"1/2	60.3	641832424	76,61
1"1/2	71.4	641833224	117,16
2"	71.4	641833232	139,69

Brida a 90° SAE 6000 PSI

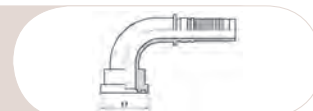

Embout bride SAE coude 90° série 6000 PSI
90° 6000 PSI SAE Flange
Flangia a 90° SAE 6000 PSI

DN	Ø	REFERENCIA PART N°	€
3/4"	41.3	642831212	22,66
3/4"	47.6	642831612	29,87
1"	47.6	642831616	28,84
1"	54	642832016	47,32
1"1/4	54	642832020	45,32
1"1/4	63.5	642832420	73,45
1"1/2	63.5	642832424	78,86
1"1/2	79.4	642833224	142,40
2"	79.4	642833232	148,71

Brida a 45° SAE 3000 PSI

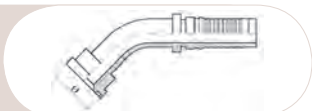

Embout bride SAE coude 45° série 3000 PSI
45° 3000 PSI SAE Flange
Flangia a 45° SAE 3000 PSI

DN	Ø	REFERENCIA PART N°	€
3/4"	38.1	641841212	24,33
3/4"	44.5	641841612	32,23
1"	44.5	641841616	32,23
1"	50.8	641842016	41,01
1"1/4	50.8	641842020	48,67
1"1/4	60.3	641842420	67,59
1"1/2	60.3	641842424	76,61
1"1/2	71.4	641843224	117,16
2"	71.4	641843232	139,69

Brida a 45° SAE 6000 PSI

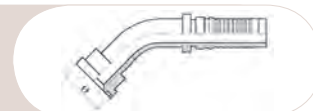

Embout bride SAE coude 45° série 6000 PSI
45° 6000 PSI SAE Flange
Flangia a 45° SAE 6000 PSI

DN	Ø	REFERENCIA PART N°	€
3/4"	41.3	642841212	25,24
3/4"	47.6	642841612	33,80
1"	47.6	642841616	35,15
1"	54	642842016	47,32
1"1/4	54	642842020	52,27
1"1/4	63.5	642842420	70,30
1"1/2	63.5	642842424	78,86
1"1/2	79.4	642843224	143,30
2"	79.4	642843232	148,71

Conexiones Interlock

Embouts à sertir Interlock
Interlock serie fittings
Raccordi serie Interlock

Brida Caterpillar 9000 PSI

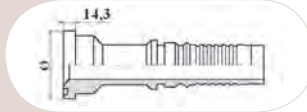

Embout bride droit Caterpillar serie 9000 PSI
9000 PSI Caterpillar Straight flange
Flangia Caterpillar 9000 PSI

DN	Ø	REFERENCIA PART N°	€
3/4"	41.3	643821212	22,01
3/4"	47.6	643821612	30,35
1"	47.6	643821616	29,26
1"	54	643822016	39,06
1"1/4	54	643822020	38,92
1"1/4	63.5	643822420	54,10
1"1/2	63.5	643822424	56,27

Brida a 90° Caterpillar 9000 PSI

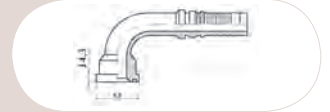

Embout bride coude 90° Caterpillar serie 9000 PSI
90° 9000 PSI Caterpillar Flange
Flangia a 90° Caterpillar 9000 PSI

DN	Ø	REFERENCIA PART N°	€
3/4"	41.3	643831212	31,28
3/4"	47.6	643831612	39,86
1"	47.6	643831616	43,97
1"	54	643832016	55,14
1"1/4	54	643832020	59,55
1"1/4	63.5	643832420	90,02
1"1/2	63.5	643832424	86,94

Brida a 45° Caterpillar 9000 PSI

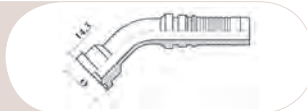

Embout bride coude 45° Caterpillar serie 9000 PSI
45° 9000 PSI Caterpillar Flange
Flangia a 45° Caterpillar 9000 PSI

DN	Ø	REFERENCIA PART N°	€
3/4"	41.3	643841212	30,93
3/4"	47.6	643841612	39,86
1"	47.6	643841616	43,97
1"	54	643842016	55,14
1"1/4	54	643842020	59,55
1"1/4	63.5	643842420	90,02
1"1/2	63.5	643842424	86,94

Espiga para brida macho Poclair



Embout bride mâle Poclair
Poclair male flange
Inserto per flangia maschio Poclair 4SH

DN	Ø	REFERENCIA PART N°	€
3/4"	3/4"	648011212	19,70
1"	1"	648011616	20,05
1"1/4	1"1/4	648012020	30,00

Espiga para brida hembra Poclair

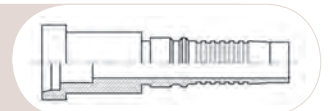

Embout bride femelle Poclair
Poclair female flange
Inserto per flangia femmina Poclair 4SH

DN	Ø	REFERENCIA PART N°	€
3/4"	3/4"	648021212	19,70
1"	1"	648021616	20,05
1"1/4	1"1/4	648022020	30,00

Brida entera macho Poclair 4 agujeros

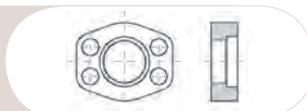

Bride rectangulaire de fixation mâle Poclair-4 trous
Male Poclair flange 4 holes
Flangia intera maschio Poclair 4 fori

TUBO PIPE	REFERENCIA PART N°	€
1/2"	448050808	12,80
5/8"	448051010	13,30
3/4"	448051212	15,50
1"	448051616	18,90
1" 1/4	448052020	28,70

Brida entera hembra Poclair 4 agujeros

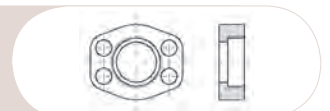

Bride rectangulaire de fixation femelle Poclair-4 trous
Female Poclair flange 4 holes
Flangia intera femmina Poclair 4 fori

TUBO PIPE	REFERENCIA PART N°	€
1/2"	448060808	12,80
5/8"	448061010	13,30
3/4"	448061212	15,50
1"	448061616	18,90
1" 1/4	448062020	28,70

Conexiones Interlock

Embouts à sertir Interlock
Interlock serie fittings
Raccordi serie Interlock

Hoses

Brida entera macho Poclair 2 agujeros

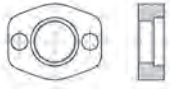

Bride oval fixation mâle Poclair 2 trous
Male Poclair flange 2 holes
Flangia intera maschio Poclair 2 fori

TUBO PIPE	REFERENCIA PART N°	€
1/2"	448070808	18,50
5/8"	448071010	19,21
3/4"	448071212	22,65
1"	448071616	24,80
1"1/4	448072020	39,50

Brida entera hembra Poclair 2 agujeros



Bride oval fixation femelle Poclair 2 trous
Female Poclair flange 2 holes
Flangia intera femmina Poclair 2 fori

TUBO PIPE	REFERENCIA PART N°	€
1/2"	448080808	15,10
5/8"	448081010	15,30
3/4"	448081212	26,15
1"	448081616	19,35
1"1/4	448082020	21,05

Flexible hose fittings

Stainless steel hoses
and fittings

Hembras rectas ORFS



Embout femelle droit ORFS
ORFS Swivel female
Femmina diritta ORFS Interlock

TUBO PIPE	ROSCA THREAD	REFERENCIA PART N°	€
3/4"	1" 3/16	649001212	15,20
1"	1" 7/16	649001616	29,29
1" 1/4	1" 11/16	649002020	34,70
1" 1/2	2"	649002424	55,30

Codos 90° ORFS

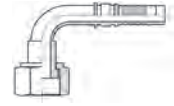

Embout coude 90° femelle ORFS
90° ORFS Swivel female
Curva a 90° ORFS Interlock

TUBO PIPE	ROSCA THREAD	REFERENCIA PART N°	€
3/4"	1" 3/16	649071212	24,86
1"	1" 7/16	649071616	36,05
1" 1/4	1" 11/16	649072020	47,77
1" 1/2	2"	649072424	71,29

Low pressure

Codos 45° ORFS

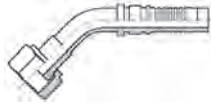

Embout coude 45° femelle ORFS
45° ORFS Swivel female
Curva a 45° ORFS Interlock

TUBO PIPE	ROSCA THREAD	REFERENCIA PART N°	€
3/4"	1" 3/16	649081212	24,86
1"	1" 7/16	649081616	36,05
1" 1/4	1" 11/16	649082020	47,77
1" 1/2	2"	649082424	71,29

Air conditioned hoses
and fittings

Measuring flow

Racores para martillo

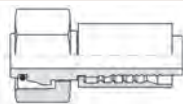

Embouts pour marteau
Fittings for hammer
Raccordi per martelli

DN	TUBO PIPE	SERIE	ROSCA THREAD	REFERENCIA PART N°	€
3/4"	25	S	M36X2	NAM362512	41,80
1"	30	S	M42X2	NAM423016	51,70
1 1/4"	38	S	M52X2	NAM523820	77,30

Se venden con casquillo incluido // Avec jupe incluse // With ferrule included //
Con boccola inclusa

Machines for
mounting flexibles

Conexiones Reusables

Embouts Récuperables
Reusable serie fittings
Raccordi serie Recuperabile

Casquillos R1A

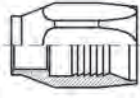

Jupes à visser R1A

Ferrules R1A

Boccola R1A

DN	REFERENCIA PART N°	€
1/4"	A1G-4 R1	2,86
3/8"	A1G-6 R1	3,65
1/2"	A1G-8 R1	4,54
5/8"	A1G-10 R1	8,75
3/4"	A1G-12 R1	9,24

Casquillos R2A

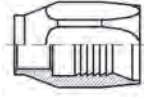

Jupes à visser R2A

Ferrules R2A

Boccola R2A

DN	REFERENCIA PART N°	€
1/4"	A1G-4 R2	2,86
5/16"	A1G-5 R2	2,94
3/8"	A1G-6 R2	3,65
1/2"	A1G-8 R2	4,54
5/8"	A1G-10 R2	8,75
3/4"	A1G-12 R2	9,24
1"	A1G-16 R2	23,03

Casquillos R2AT

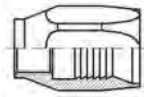

Jupes à visser R2AT

Ferrules R2AT

Boccola R2AT

DN	REFERENCIA PART N°	€
3/8"	A1G-6 R2T	5,55

Hembras giratorias rectas BSP cono 60°

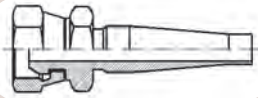

Femelle tournante gaz cyl BSP 60°

BSP Swivel female 60° cone

Femmina diritta recuperabile BSP sede 60°

DN	ROSCA THREAD	REFERENCIA PART N°	€
1/4"	1/4" BSP	A3G-4	4,72
1/4"	3/8" BSP	A3G-6-4	5,97
5/16"	3/8" BSP	A3G-6-5	5,97
3/8"	3/8" BSP	A3G-6	5,97
3/8"	1/2" BSP	A3G-8-6	8,62
1/2"	1/2" BSP	A3G-8	8,62
5/8"	5/8" BSP	A3G-10	13,21
1/2"	3/4" BSP	A3G-12-8	13,32
3/4"	3/4" BSP	A3G-12	12,99
5/8"	3/4" BSP	A3G 12-10	19,59
1"	1" BSP	A3G-16	22,26

Hembras giratorias 90° BSP cono 60°

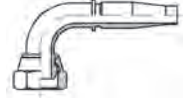

Femelle tournante coude 90° gaz cyl BSP 60°

BSP 90° Swept elbow 60° cone

Femmina a 90° recuperabile BSP sede 60°

DN	ROSCA THREAD	REFERENCIA PART N°	€
1/4"	1/4" BSP	A90G-4	5,97
5/16"	3/8" BSP	A90G-6-5	6,65
3/8"	3/8" BSP	A90G-6	6,65
3/8"	1/2" BSP	A90G-8-6	8,48
1/2"	1/2" BSP	A90G-8	8,88
1/2"	3/4" BSP	A90G-12-8	12,27
3/4"	3/4" BSP	A90G-12	15,18
3/4"	1" BSP	A90G-16-12	21,06
1"	1" BSP	A90G-16	27,86

Conexiones Reusables

Embouts Récuperables
Reusable serie fittings
Raccordi serie Recuperabile

Hoses

Flexible hose fittings

Stainless steel hoses and fittings

Low pressure

Air conditioned hoses and fittings

Measuring flow

Machines for mounting flexibles

Machos rosca cilíndrica BSP cono 60°

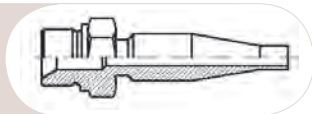

Mâle gaz cyl BSP 60°
BSP Male parallel 60° cone
Maschio cilindrico recuperabile BSP sede 60°

DN	ROSCA THREAD	REFERENCIA PART N°	€
1/4"	1/4" BSP	A2G-4	3,25
1/4"	3/8" BSP	A2G-6-4	4,11
5/16"	3/8" BSP	A2G-6-5	4,11
3/8"	3/8" BSP	A2G-6	4,11
3/8"	1/2" BSP	A2G-8-6	5,71
1/2"	1/2" BSP	A2G-8	5,71
5/8"	5/8" BSP	A2G-10	8,56
1/2"	3/4" BSP	A2G-12-8	9,39
3/4"	3/4" BSP	A2G-12	9,39
5/8"	3/4" BSP	A2G-12-10	9,39
3/4"	1" BSP	A2G-16-12	16,47
1"	1" BSP	A2G-16	16,47

Machos Stecko

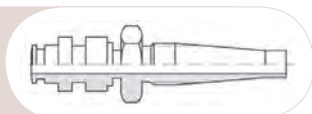

Mâle Stecko
Male Stecko connections
Maschio Stecko recuperabile

DN	STECKO	REFERENCIA PART N°	€
1/4"	1/4"	S2G-4	3,62
1/4"	3/8"	S2G-6-4	6,19
1/2"	1/2"	S2G-8	3,00
1"1/4"	1"1/4"	S2G-20	28,51

Hasta fin de existencias // Jusqu'à la fin du stock // Until end of stock // Fino ad esaurimento scorta

Espigas lisas Métricas

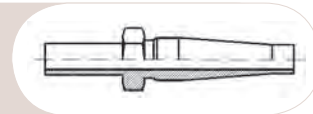

Embout lisse Métrique
Metric Standpipe
Estremità tubolare Metrica recuperabile

DN	TUBO PIPE	REFERENCIA PART N°	€
1/4"	6	AE 6-4	8,32
1/4"	8	AE 8-4	8,32
1/4"	10	AE 10-4	9,44
5/16"	10	AE 10-5	9,44
3/8"	10	AE 10-6	12,46
5/16"	12	AE 12-5	12,46
3/8"	12	AE 12-6	12,46
1/2"	15	AE 15-8	14,43
1/2"	16	AE 16-8	14,43
5/8"	18	AE 18-10	17,13
5/8"	20	AE 20-10	17,13
3/4"	22	AE 22-12	20,49
3/4"	25	AE 25-12	20,49

Orientables BSP

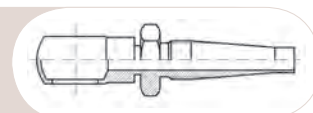

Banjo droit tube gaz cyl BSP
Banjo BSP
Raccordo ad occhio BSP recuperabile

DN	Ø	REFERENCIA PART N°	€
1/4"	1/4" BSP	AOG-4	6,43
5/16"	3/8" BSP	AOG-6-5	8,38
3/8"	3/8" BSP	AOG-6	8,38
3/8"	1/2" BSP	AOG-8-6	11,88
1/2"	1/2" BSP	AOG-8	11,88
1/2"	3/4" BSP	AOG-12-8	25,33
3/4"	3/4" BSP	AOG-12	23,45
3/4"	1" BSP	AOG-16-12	43,89
1"	1" BSP	AOG-16	51,55

Conexiones alta presión (700 Bar)

Embouts haute pression 700 Bar
High pressure 700 Bar fittings
Raccordi Altissima pressione (700 Bar)

Manguera termoplástica 700 bar



Tuyau thermoplastique haute pression 700 bar
Thermoplastic hose 700 bar
Tubo termoplastico 700 bar

DN	Ø int	REFERENCIA PART N°	€
1/4"	6	M352004	21,61

Casquillos manguera 700 bar tipo M352

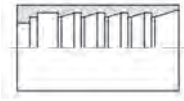

Jupes à sertir thermoplastique 700 bar type M352
Ferrules for thermoplastic hose 700 bar
Boccole per tubo termoplastico 700 bar tipo M352

DN	REFERENCIA PART N°	€
1/4"	710120400	2,41

Hembra giratoria recta BSP 60°



Embout thermoplastique 700 bar femelle tournant gaz cyl BSP 60°
BSP Swivel female 60° cone
Femmina diritta BSP sede 60°

DN	ROSCA THREAD	REFERENCIA PART N°	€
1/4"	1/4" BSP	741000404	7,42

Macho NPT

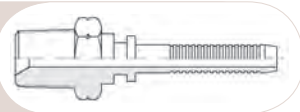

Embout thermoplastique 700 bar mâle fixe gaz conique NPT
NPT Male thread
Maschio conico NPT

DN	ROSCA THREAD	REFERENCIA PART N°	€
1/4"	1/4" NPT	741610404	4,51
1/4"	3/8" NPT	741610604	4,39

Macho BSP 60°

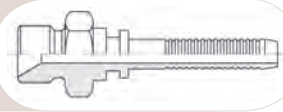

Embout thermoplastique 700 bar mâle fixe gaz cyl BSP 60°
BSP Male parallel 60° cone
Maschio cilindrico BSP sede 60°

DN	ROSCA THREAD	REFERENCIA PART N°	€
1/4"	1/4" BSP	741120404	5,62

Hembra giratoria recta JIC 37°

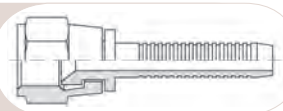

Embout femelle tournant droit JIC 74°
JIC Swivel female 37° cone
Femmina JIC 37°

DN	ROSCA THREAD	REFERENCIA PART N°	€
1/4"	1/2" UNF	741420804	42,83
1/4"	9/16" UNF	741420904	24,29

Serie Standard

Standard serie | Serie Standard | Standard serie

Hoses

Flexible hose fittings

Stainless steel hoses and fittings

Low pressure

Air conditioned hoses and fittings

Measuring flow

Machines for mounting flexibles

► **Una única conexión para una amplia gama de mangueras** | Un seul raccord pour une grande gamme de tubes | One only fitting for a big tubes range | Un solo raccordo per una vasta gamma di tubi

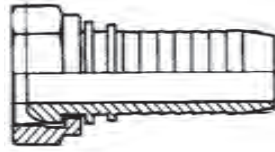

EN 857 1 SC	SUPERSERVICE 155° 1SC	R8	SAE 100 R7	Metallic Braid Elastomer	SAE 100 R6	Smooth PTFE 1 Braid	Convoluté PTFE
81014...	81014...	81014... 81012...	81014... 81012...	81014... 81012...	81014... 81012...	81040...	81041...

EN 853 1ST SAE 100 R1A	EN 853 1 SN SAE 100 R1AT	EN 853 2SN SAE 100 R2AT	EN 857 2SC SAE 100 R16	SUPERSERVICE 155° 2SC	EN 853 2ST SAE 100 R2A	EN 856 4SP	EN 856 R12
82003...	ZPF22120...	ZPF22120...	ZPF22120...	ZPF22120...	ZPF12240...	ZPF12240...	ZPF12240...

Serie Interlock

Série interlock | Interlock serie | Serie Interlock

► **Una única conexión para toda la gama de mangueras de alta presión** | Un seul raccord pour tous les tubes de très haute pression | One only fitting for all very high pressure tubes | Un solo raccordo per tutti i tubi ad altissima pressione

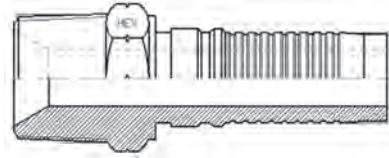

	4 SH	R 13	R 15	
	 ZA61010... Z61010...	 ZA61010... Z61010...	 ZA61010... Z61010...	

Tabla de prensados para mangueras hidráulicas

Tableau sertissage pour les tuyaux hydrauliques | Crimping table for hydraulic hoses |
Tabella di pressatura per tubi idraulici

Tolerancias de prensado | Tolerance de sertissage | Crimping tolerances | Toleranza di pressatura
1/8" - 3/8" : + 0 / - 0,2 | 1/2" - 2" 1/2 : + 0 / - 0,4

Manguera Tuyaux Hose Tubo	DN (mm) Pulgadas Pouces Inches Inch Galga Piges Gauge size	5	6	8	10	12	16	19	25	31	38	51
EN 857 1SC M1SC	Casquillo Jupe Ferrule Boccia	-	PF23	PF23	PF23	-	-	-	-	-	-	-
	Ø Ext. casquillo Jupe Ferrule Boccia		18	19	22							
	Ø Ext. manguera Tuyaux Hose Tubo		11,6	14,2	15,7							
	Ø Prensado Sertissage Crimping Pressatura		14,8	16,3	18,8							
EN 857 2SC M2SC	Casquillo Jupe Ferrule Boccia	-	-	PF2212	PF2212	PF2212	-	-	-	-	-	-
	Ø Ext. casquillo Jupe Ferrule Boccia			24	26	29						
	Ø Ext. manguera Tuyaux Hose Tubo			14,7	17	20,6						
	Ø Prensado Sertissage Crimping Pressatura			18,9	20,9	23,6						
SAE 100 R1AT EN 853 1SN M2230	Casquillo Jupe Ferrule Boccia	PF2212	PF2212	PF2212	PF2212	PF2212	PF2212	PF2212	PF2212	PF2212	PF2212	PF2212
	Ø Ext. casquillo Jupe Ferrule Boccia	21	23	24	26	29	33	37	46	59	67	80
	Ø Ext. manguera Tuyaux Hose Tubo	11,5	13,5	15,4	17,5	20,3	23,9	28,2	36	44	50,3	64
	Ø Prensado Sertissage Crimping Pressatura	15,7	18,1	19,2	20,8	23,1	27,5	31,5	39,5	48,8	57	70
SAE 100 R2AT EN 853 2SN M3511	Casquillo Jupe Ferrule Boccia	PF2212	PF2212	PF2212	PF2212	PF2212	PF2212	PF2212	PF2212	PF2212	PF2212	PF2212
	Ø Ext. casquillo Jupe Ferrule Boccia	21	23	24	26	29	33	37	46	59	67	80
	Ø Ext. manguera Tuyaux Hose Tubo	13,2	14,8	16,6	18,9	22	25,3	29	37	47,5	54,3	66,7
	Ø Prensado Sertissage Crimping Pressatura	16,2	18,8	19,8	22	24,2	28,7	32,6	40,5	51,8	60	72,5
SAE 100 R1A EN 853 1ST ML2231	Casquillo Jupe Ferrule Boccia	22003	22003	22003	22003	22003	22003	22003	22003	22003	22003	22003
	Ø Ext. casquillo Jupe Ferrule Boccia	18	20	21	24	28	31	35	42	52	58	71
	Ø Prensado Sertissage Crimping Pressatura	15,5	17,8	18,8	21,7	25,2	28,8	32,5	38,8	49	55	66
	Pelado ext. Denudage ext. Ext. Skive Pelatura esterna	22,5	22,5	22,5	22,5	26	27	31	39	45	50	58
SAE 100 R2A EN 853 2ST ML3509	Casquillo Jupe Ferrule Boccia	PF1224	PF1224	PF1224	PF1224	PF1224	PF1224	PF1224	PF1224	PF1224	PF1224	PF1224
	Ø Ext. casquillo Jupe Ferrule Boccia	21	22	23	26	30	33	38	46	57	65	79
	Ø Prensado Sertissage Crimping Pressatura	18,2	17,6	20	22,5	26,3	29,1	33,8	42,2	51	59	72,3
	Pelado ext. Denudage ext. Ext. Skive Pelatura esterna	22,5	21	22	23	23	26,5	31	38	45	49	60
SAE 100 R9R-R10 EN 856 4SP ML4290-ML4248	Casquillo Jupe Ferrule Boccia	-	PF1224	-	PF1224	PF1224	PF1224	PF1224	PF1224	PF1224	PF1224	PF1224
	Ø Ext. casquillo Jupe Ferrule Boccia		22		26	30	33	38	46	57	65	79
	Ø Prensado Sertissage Crimping Pressatura		18,8		23,4	26,5	29,7	34,4	42,2	51,7	59,7	73
	Pelado ext. Denudage ext. Ext. Skive Pelatura esterna		21		23	23,5	26,5	31	38	45	49	60
SAE 100 R12 EN 856 R12 M4612	Casquillo Jupe Ferrule Boccia	-	-	-	-	PF1224	-	PF1224	PF1224	PF1224	PF1224	
	Ø Ext. casquillo Jupe Ferrule Boccia					30		38	46	57	65	
	Ø Prensado Sertissage Crimping Pressatura					26,7		34,4	42,2	50,5	59,7	
	Pelado ext. Denudage ext. Ext. Skive Pelatura esterna					23,5		31	38	45	49	
EN 856 4SH Conex. interlock ML4569	Casquillo Jupe Ferrule Boccia	-	-	-	-	-	-	A61010	A61010	A61010	A61010	A61010
	Ø Ext. casquillo Jupe Ferrule Boccia							40	47	56	63	80
	Ø Prensado Sertissage Crimping Pressatura							35,5	42	50	57	74
	Pelado int. Denudage int. Inn. Skive Pelatura interna							17	18	21	24	26
SAE 100 R13 EN 856 R13 Conex. interlock M4713	Casquillo Jupe Ferrule Boccia	-	-	-	-	-	-	A61010	A61010	61010	61010	61010
	Ø Ext. casquillo Jupe Ferrule Boccia							40	47	61	70	85
	Ø Ext. manguera Tuyaux Hose Tubo							32,1	38,3	49,7	57,2	70,8
	Ø Prensado Sertissage Crimping Pressatura							36	42,5	55	64	79
SAE 100 R15 SAE J517 R 15 Conex. interlock M4815	Casquillo Jupe Ferrule Boccia	-	-	-	-	-	-	A61010	A61010	61010	61010	-
	Ø Ext. casquillo Jupe Ferrule Boccia							40	47	61	70	
	Ø Prensado Sertissage Crimping Pressatura							35,5	42	54,5	64	
	Pelado int. Denudage int. Inn. Skive Pelatura interna							17	18	21	24	
SAE 100 R16 M4900	Casquillo Jupe Ferrule Boccia	-	PF2212	-	PF2212	PF2212	-	-	-	-	-	22003
	Ø Ext. casquillo Jupe Ferrule Boccia		23		26	29						52
	Ø Ext. manguera Tuyaux Hose Tubo		12,3		16,8	20,7						42,6
	Ø Prensado Sertissage Crimping Pressatura		17,5		20,5	23,9						47

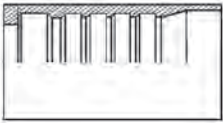
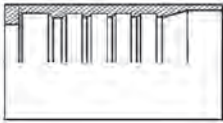
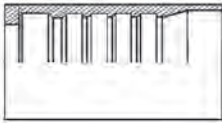
NOTA: Las tablas de prensado DICSA son siempre orientativas | Tableau sertissage DICSA sont toujours indicatifs | Crimping lists of DICSA are always orientatives | Le tabelle di pressatura DICSA sono sempre orientative.

Los diámetros de prensado han sido validados para estos diámetros exteriores de manguera. Por lo tanto, éstos diámetros pueden variar dependiendo de la manguera | Les diamètres de sertissage ont été vérifiés pour ces diamètres de tuyau. C'est pourquoi, ces diamètres peuvent changer selon le tuyau | Crimping diameters have been validated for these outer diameters of the hoses. Therefore, these diameters can change depending on the hose | I diametri di pressatura sono stati testati per questi diametri esterni di tubo. Saranno quindi passibili di variazione con il variare Della natura dei tubi.

Tabla de prensados para mangueras de teflón y termoplásticas

Tableau sertissage pour les tuyaux teflon et thermoplastiques | Crimping table for PTFE and thermoplastic hoses |
Tabella di pressatura per PTFE e tubi termoplastica

Tolerancias de prensado | Tolerance de sertissage | Crimping tolerances | Toleranza di pressatura
1/8" - 3/8" : + 0 / - 0,2 | 1/2" - 2" 1/2 : + 0 / - 0,4

Manguera Tuyau Hose Tubo	DN (mm) Pulgadas Pouces Inches Inch Gauga Piges Gauge size	3	5	6	8	10	13	16	19	22	25	32	38	50	63
		1/8"	3/16"	1/4"	5/16"	3/8"	1/2"	5/8"	3/4"	7/8"	1"	1 1/4"	1 1/2"	2"	2 1/2"
Teflon FHL M2900	Casquillo Jupe Ferrule Boccolla	-	21040	21040	21040	21040	21040	21040	21040	21040	21040	-	-	-	-
	Ø Ext. casquillo Jupe Ferrule Boccolla		14	15	17	18	24	28	30	34	36				
Teflon FHM (2 mallas tresses braids trecce) M29012	Casquillo Jupe Ferrule Boccolla	-	-	PF23	PF23	PF23	21040	21040	21040	-	21012	-	-	-	-
	Ø Ext. casquillo Jupe Ferrule Boccolla			18	19	22	24	28	30	40					
Teflon (coarrugado convoluted convoluted PTFE corrugato) M2920 (1)	Casquillo Jupe Ferrule Boccolla	-	-	21041	21041	21041	21041	21041	21041	-	21041	21041	21041	21041	21041
	Ø Ext. casquillo Jupe Ferrule Boccolla			16	17	21,5	25	29	34		40	48	55	69	80
SAE 100 R7 M096	Casquillo Jupe Ferrule Boccolla	21012	PF23	PF23	PF23	PF23	PF23	21012	21012	-	21012	-	-	-	-
	Ø Ext. casquillo Jupe Ferrule Boccolla	13	14	18	19	22	26	29	31,5		40				
SAE 100 R8 M1030	Casquillo Jupe Ferrule Boccolla	-	PF23	PF23	PF23	PF23	PF23	-	21012	-	21012	-	-	-	-
	Ø Ext. casquillo Jupe Ferrule Boccolla		14	18	19	22	26		31,5		40				
Elastomero malla metálica Élastomère 1 tresse métallique Metallic braid elastomer Maglia metalica per vernici M087	Casquillo Jupe Ferrule Boccolla	-	PF23	PF23	PF23	PF23	PF23	21012	21012	-	21012	-	-	-	-
	Ø Ext. casquillo Jupe Ferrule Boccolla		14	18	19	22	26	29	31,5		40				
Elastomero malla metálica pintura Élastomère peinture 1 tresse métallique Paint metallic braid elastomer Maglia metalica M083	Casquillo Jupe Ferrule Boccolla	-	22003	22003	21012	22003	22003	-	21012	-	21012	-	-	-	-
	Ø Ext. casquillo Jupe Ferrule Boccolla		14	18	19	22	26		31,5		40				
Elastomero doble malla metálica pintura Élastomère peinture 2 tresses métalliques Paint metal. braid double elastomer Doppia maglia metalica per vernici M081	Casquillo Jupe Ferrule Boccolla	-	-	PF1224	PF1224	PF1224	PF1224	-	PF1224	-	PF1224	-	-	-	-
	Ø Ext. casquillo Jupe Ferrule Boccolla			22	23	26	30		37		46				
Manguera altísima presión Tuyau haute pression High pressure hose Tubo altissima pressione M3520	Casquillo Jupe Ferrule Boccolla	-	-	71012	-	-	-	-	-	-	-	-	-	-	-
	Ø Ext. casquillo Jupe Ferrule Boccolla			20											
Manguera Minimax 2 x 5 mm Tuyau Minimax 2 x 5 mm Minimax hose 2 x 5 mm Tubo Minimax 2 x 5 mm M089K02	Casquillo Jupe Ferrule Boccolla	555010100	-	-	-	-	-	-	-	-	-	-	-	-	-
	Ø Ext. casquillo Jupe Ferrule Boccolla	8													
Ecology 200 MEC200...	Casquillo Jupe Ferrule Boccolla	-	-	-	-	-	-	21200	-	21200	-	-	-	-	-
	Ø Ext. casquillo Jupe Ferrule Boccolla							31,4		38					

Antiguo casquillo | Vieux jupe | Old ferrule | Boccolla vecchia

Manguera Tuyau Hose Tubo	DN (mm) Pulgadas Pouces Inches Inch Gauga Piges Gauge size	3	5	6	8	10	13	16	19	22	25	32	38	50	63
		1/8"	3/16"	1/4"	5/16"	3/8"	1/2"	5/8"	3/4"	7/8"	1"	1 1/4"	1 1/2"	2"	2 1/2"
SAE 100 R7 M096	Casquillo Jupe Ferrule Boccolla	-	21012	21012	21012	21012	21012	-	-	-	-	-	-	-	-
	Ø Ext. casquillo Jupe Ferrule Boccolla		14	16	19	21	25								
Elastomero malla metálica Élastomère 1 tresse métallique Metallic braid elastomer Maglia metalica per vernici M087	Casquillo Jupe Ferrule Boccolla	-	21012	21012	21012	21012	21012	-	-	-	-	-	-	-	-
	Ø Ext. casquillo Jupe Ferrule Boccolla		14	16	19	21	25								

NOTA: Las tablas de prensado DICSА son siempre orientativas | Tableau sertissage DICSА sont toujours indicatifs | Crimping lists of DICSА are always orientatives | Le tabella di pressatura DICSА sono sempre orientative.

(1) Los diámetros de prensado de las mangueras de teflón coarrugado, se corresponden con los ensayados para mangueras de nuestro proveedor. Por lo tanto estos diámetros pueden variar dependiendo de la manguera. Se recomienda que en diámetros de prensado de 1 1/4, 1 1/2 y 2" se comprueben todos los montajes que se realicen | Les diamètres de sertissage du teflon convoluted sont suite aux diamètres de sertissage des tuyaux de notre fournisseur. C'est pourquoi, ces diamètres peuvent changer selon le tuyau. Pour diamètres de sertissage de 1 1/4, 1 1/2 et 2", on recommand de verifier tous les montages | Crimping diameters of convoluted PTFE are according the tests of crimping diameters for hoses of our supplier. Therefore, these diameters can change depending on the hose. For crimping diameters 1 1/4, 1 1/2 and 2", it es recommended to check all the assemblies | I diametri di pressatura relativi al tubo PTFE corrugato, sono stati ottenuti e testati sui tubi del nostro programma di vendita. Questi diametri potranno quindi cambiare, al cambiare della loro origine. Nei diametri 1 1/4, 1 1/2 e 2" è consigliato il controllo della pressatura di ogni singolo tubo assemblato.

(2) Los diámetros de prensado han sido validados para estos diámetros exteriores de manguera. Por lo tanto, éstos diámetros pueden variar dependiendo de la manguera | Les diamètres de sertissage ont été vérifiés pour ces diamètres de tuyau. C'est pourquoi, ces diamètres peuvent charger selon le tuyau | Crimping diameters have been validated for these outer diameters of the hoses. Therefore, these diameters can change depending on the hose | I diametri di pressatura sono stati testati per questi diametri esterni di tubo. Saranno quindi passibili di variazione con il variare Della natura dei tubi.

Manguera Inox, Racores y Bridas soldables

Tuyau Inox, raccords et brides à souder

Stainless steel hose, welding fittings and forged flanges

Tubi Inox, raccordi e flange a saldare

3

Manguera Inox, Racores y Bidas soldables

60

Tuyau Inox, raccords et brides à souder | Stainless steel hose, welding fittings and forged flanges
| Tubi Inox, raccordi e flange a saldare

Manguera Inox, Racores y Bridas soldables

Tuyau Inox, raccords et brides à souder | Stainless steel hose, welding fittings and forged flanges | Tubi Inox, raccordi e flange a saldare

Hoses

Flexible hose fittings

Stainless steel hoses
and fittings

Low pressure

Air conditioned hoses
and fittings

Measuring flow

Machines for
mounting flexibles

▶ Mangueras Inox coarrugado | Tuyaux inox onduleux | Convoluted stainless steel hoses | Tubi Inox corrugato

61



M93211

M93212

M93161

▶ Racores soldables BSP | Raccords à souder BSP | BSP Welding fittings | Raccordi a saldare BSP

62



A1278

A1273

A1270

A1035

A1032

81070

▶ Bridas fijas para soldar | Brides DIN à souder fixes | Fixed Forged flanges | Flange a saldare

63



BPN162633

BANSAWN150

BPN402635

BANSAWN300

▶ Conjunto brida DIN 2642 | Ensemble brides tournantes DIN 2642 | DIN 2642 swivel flanges set | Flangia girevole DIN 2642

64

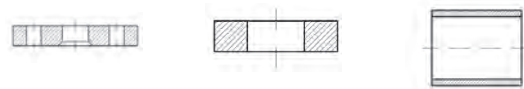

BPN102642

ABARO2642

ABTUB

▶ Conjunto brida DIN 2656 | Ensemble brides tournantes DIN 2656 | DIN 2656 swivel flanges set | Flangia girevole DIN 2656

65

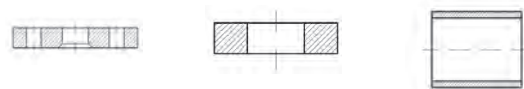

BPN402656

ABARO2656

ABTUB

▶ Conjunto brida ANSI-ASA | Ensemble brides ANSI-ASA | ANSI-ASA swivel flanges set | Flangia girevole ANSI-ASA

66



BANSASO150

BANSASO300

ABAROANSA

ABTUB

Manguera Inox, Racores y Bridas soldables

Tuyau Inox, raccords et brides à souder
Stainless steel hose, welding fittings and forged flanges
Tubi Inox, raccordi e flange a saldare

Inox coarrugado AISI 321 con una malla AISI 304



Inox onduleux AISI 321 avec une tresse inox AISI 304
Convuluted S.S. AISI 321 hose with one braid S.S. AISI 304
Tubo in Inox corrugato 321 con una maglia AISI 304

DN	TUBO PIPE	REFERENCIA PART N°	€
6	1/4"	M93211006	8,94
10	3/8"	M93211010	9,83
12	1/2"	M93211012	10,73
16	5/8"	M93211016	16,98
20	3/4"	M93211020	21,45
25	1"	M93211025	27,71
32	1" 1/4	M93211032	32,18
40	1" 1/2	M93211040	41,56
50	2"	M93211050	58,54
65	2" 1/2	M93211065	82,23
80	3"	M93211080	95,19
100	4"	M93211100	123,34

Inox coarrugado AISI 321 con dos mallas AISI 304



Inox onduleux AISI 321 avec deux tresses inox AISI 304
Convuluted S.S. AISI 321 hose with two braids S.S. AISI 304
Tubo in Inox corrugato 321 con due maglie AISI 304

DN	TUBO PIPE	REFERENCIA PART N°	€
6	1/4"	M93212006	11,62
10	3/8"	M93212010	13,41
12	1/2"	M93212012	14,75
20	3/4"	M93212020	30,39
25	1"	M93212025	38,43
32	1" 1/4	M93212032	45,58
40	1" 1/2	M93212040	60,33
50	2"	M93212050	85,36
65	2" 1/2	M93212065	115,74
80	3"	M93212080	133,17
100	4"	M93212100	173,39

Inox coarrugado AISI 316 con una malla AISI 316

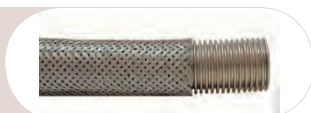

Inox onduleux AISI 316 avec une tresse inox AISI 316
Convuluted S.S. AISI 316 hose with one braid S.S. AISI 316
Tubo in Inox corrugato 316 con una maglia AISI 316

DN	TUBO PIPE	REFERENCIA PART N°	€
6	1/4"	M93161006	12,07
10	3/8"	M93161010	14,30
12	1/2"	M93161012	16,98
20	3/4"	M93161020	32,18
25	1"	M93161025	37,99
32	1" 1/4	M93161032	58,10
40	1" 1/2	M93161040	67,03
50	2"	M93161050	89,38
65	2" 1/2	M93161065	120,66
80	3"	M93161080	140,32
100	4"	M93161100	184,57

Manguera Inox, Racores y Bridas soldables

Tuyau Inox, raccords et brides à souder
Stainless steel hose, welding fittings and forged flanges
Tubi Inox, raccordi e flange a saldare

Hoses

Flexible hose fittings

Stainless steel hoses
and fittings

Low pressure

Air conditioned hoses
and fittings

Measuring flow

Machines for
mounting flexibles

Cono ajuste 60° con guía

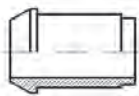

Collet cone 60° à souder (bw) + guide
Welding nipple 60° cone for BSP nut with guide
Ogiva a saldare sede 60° per dado BSP con guida

DN	ROSCA THREAD	REFERENCIA PART N°	€
1/4"	1/4" BSP	A127804	0,48
3/8"	3/8" BSP	A127806	0,47
1/2"	1/2" BSP	A127808	0,79
3/4"	3/4" BSP	A127812	1,15
1"	1" BSP	A127816	1,88
1" 1/4	1" 1/4 BSP	A127820	3,53
1" 1/2	1" 1/2 BSP	A127824	5,99
2"	2" BSP	A127832	10,31
2" 1/2	2" 1/2 BSP	A127840	14,57

Macho BSP cono 60° con guía

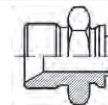

Mamelon hexagonal gaz cyl BSP à souder (bw) + guide
Welding adaptor BSP 60°
Maschio BSP a saldare sede 60° con guida

DN	ROSCA THREAD	REFERENCIA PART N°	€
1/4"	1/4" BSP	A103504	0,87
3/8"	3/8" BSP	A103506	1,01
1/2"	1/2" BSP	A103508	1,44
3/4"	3/4" BSP	A103512	2,38
1"	1" BSP	A103516	3,46
1" 1/4	1" 1/4 BSP	A103520	7,93
1" 1/2	1" 1/2 BSP	A103524	11,10
2"	2" BSP	A103532	17,88

Cono ajuste sin guía

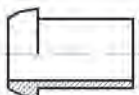

Collet à souder sans guide
Welding nipple without guide
Ogiva a saldare BSP

DN	ROSCA THREAD	REFERENCIA PART N°	€
1/4"	1/4" BSP	A127304	0,40
3/8"	3/8" BSP	A127306	0,43
1/2"	1/2" BSP	A127308	0,79
3/4"	3/4" BSP	A127312	0,94
1"	1" BSP	A127316	1,66
1" 1/4	1" 1/4 BSP	A127320	2,38
1" 1/2	1" 1/2 BSP	A127324	4,18
2"	2" BSP	A127332	5,91

Macho cónico BSPT con guía



Mamelon hexagonal gaz conique à souder (bw) + guide
Welding adaptor BSPT
Maschio conico BSPT con guida

DN	ROSCA THREAD	REFERENCIA PART N°	€
1/4"	1/4" BSPT	A103204	1,66
3/8"	3/8" BSPT	A103206	1,88
1/2"	1/2" BSPT	A103208	2,52
3/4"	3/4" BSPT	A103212	4,18
1"	1" BSPT	A103216	4,69
1" 1/4	1" 1/4 BSPT	A103220	11,90
1" 1/2	1" 1/2 BSPT	A103224	11,75
2"	2" BSPT	A103232	16,37
2" 1/2	2" 1/2 BSPT	A103240	43,91

Tuerca cono ajuste rosca BSP



Écrou gaz pour collet à souder bw (60°)
BSP nut for welding nipple 60° cone
Dado BSP per ogiva a saldare

ROSCA THREAD	REFERENCIA PART N°	€
1/4" BSP	A127004	0,58
3/8" BSP	A127006	0,65
1/2" BSP	A127008	0,79
3/4" BSP	A127012	0,94
1" BSP	A127016	2,09
1" 1/4 BSP	A127020	4,33
1" 1/2 BSP	A127024	5,77
2" BSP	A127032	8,94
2" 1/2 BSP	A127040	18,78

Casquillo soldable Inox coarugado



Jupe à souder Inox convoluté
Convolute SS welding ferrule
Boccola a saldare per inox coarugato

DN	Ø int	REFERENCIA PART N°	€
1/4"	14	810700400	1,47
3/8"	19	810700600	1,68
1/2"	22	810700800	2,15
5/8"	25	810701000	2,45
3/4"	30	810701200	2,65
1"	38	810701600	3,97
1" 1/4	47.8	810702000	4,65
1" 1/2	56.1	810702400	4,98
2"	70	810703200	7,85
2" 1/2	84.8	810704000	16,35
3"	108.2	810704800	19,85
4"	125	810706400	25,80

Manguera Inox, Racores y Bridas soldables

Tuyau Inox, raccords et brides à souder
Stainless steel hose, welding fittings and forged flanges
Tubi Inox, raccordi e flange a saldare

Brida fija DIN 2633 PN 10/16

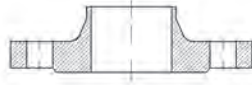

Bride fixe avec collerette DIN 2633 PN 10/16 à souder
Fixed forged flange DIN 2633 PN 10/16
Flangia fissa a saldare DIN 2633 PN 10/16

DN	REFERENCIA PART N°	€
3/8"	BPN16263306	8,52
1/2"	BPN16263308	11,82
3/4"	BPN16263312	18,53
1"	BPN16263316	19,80
1" 1/4	BPN16263320	20,26
1" 1/2	BPN16263324	22,50
2"	BPN16263332	30,36
2" 1/2	BPN16263340	36,77
3"	BPN16263348	44,42
4"	BPN16263364	55,88

Brida fija DIN 2635 PN 40

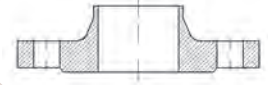

Bride fixe avec collerette DIN 2635 PN 40 à souder
Fixed forged flange DIN 2635 PN 40
Flangia fissa a saldare DIN 2635 PN 40

DN	REFERENCIA PART N°	€
3/8"	BPN40263506	8,94
1/2"	BPN40263508	12,41
3/4"	BPN40263512	19,45
1"	BPN40263516	20,79
1" 1/4	BPN40263520	21,27
1" 1/2	BPN40263524	23,62
2"	BPN40263532	31,87
2" 1/2	BPN40263540	38,61
3"	BPN40263548	46,63
4"	BPN40263564	58,67

Brida ANSI-ASA Neck 150 LBS



Bride ANSI-ASA w. Neck 150 LBS
Flange ANSI-ASA w. Neck 150 LBS
Flangia ANSI-ASA 150 LBS

DN	REFERENCIA PART N°	€
1/2"	BANSAWN15008	13,00
3/4"	BANSAWN15012	20,38
1"	BANSAWN15016	21,78
1" 1/4	BANSAWN15020	22,28
1" 1/2	BANSAWN15024	24,75
2"	BANSAWN15032	31,87
2" 1/2	BANSAWN15040	40,45
3"	BANSAWN15048	48,85
4"	BANSAWN15064	61,47

Brida ANSI-ASA Neck 300 LBS



Bride ANSI-ASA w. Neck 300 LBS
Flange ANSI-ASA w. Neck 300 LBS
Flangia ANSI-ASA Neck 300 LBS

DN	REFERENCIA PART N°	€
1/2"	BANSAWN30008	12,64
3/4"	BANSAWN30012	19,83
1"	BANSAWN30016	21,18
1" 1/4	BANSAWN30020	21,62
1" 1/2	BANSAWN30024	24,06
2"	BANSAWN30032	32,47
2" 1/2	BANSAWN30040	39,34
3"	BANSAWN30048	47,52
4"	BANSAWN30064	59,80

Manguera Inox, Racores y Bridas soldables

Tuyau Inox, raccords et brides à souder
Stainless steel hose, welding fittings and forged flanges
Tubi Inox, raccordi e flange a saldare

Hoses

Flexible hose fittings

Stainless steel hoses
and fittings

Low pressure

Air conditioned hoses
and fittings

Measuring flow

Machines for
mounting flexibles

Brida loca DIN 2642 PN 10

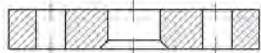

Bride plate tournante DIN 2642 PN 10 à souder
Swivel forged flange DIN 2642 PN 10
Flangia girevole a saldare DIN 2642 PN 10

DN	REFERENCIA PART N°	€
1/2"	BPN10264208	7,14
3/4"	BPN10264212	8,36
1"	BPN10264216	11,83
1" 1/4	BPN10264220	17,02
1" 1/2	BPN10264224	19,32
2"	BPN10264232	22,86
2" 1/2	BPN10264240	27,26
3"	BPN10264248	34,54
4"	BPN10264264	43,20

Tubo soldar brida ANSI-DIN



Tube à souder brides ANSI-DIN
Tube for welding flanges ANSI-DIN
Tubo per flangia a saldare ANSI-DIN

DN	REFERENCIA PART N°	€
3/8"	ABTUB006	1,74
1/2"	ABTUB008	1,83
3/4"	ABTUB012	2,31
1"	ABTUB016	3,07
1" 1/4	ABTUB020	3,76
1" 1/2	ABTUB024	4,62
2"	ABTUB032	6,14
2" 1/2	ABTUB040	6,51
3"	ABTUB048	7,88
4"	ABTUB064	12,00

Aro para brida DIN 2642

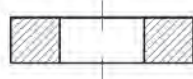

Collet épais pour bride DIN 2642
Ring for flange DIN 2642
Anello per flangia DIN 2642

DN	REFERENCIA PART N°	€
3/8"	ABARO264206	3,99
1/2"	ABARO264208	5,20
3/4"	ABARO264212	5,93
1"	ABARO264216	7,62
1" 1/4	ABARO264220	8,73
1" 1/2	ABARO264224	10,93
2"	ABARO264232	13,91
2" 1/2	ABARO264240	16,51
3"	ABARO264248	20,82
4"	ABARO264264	52,50

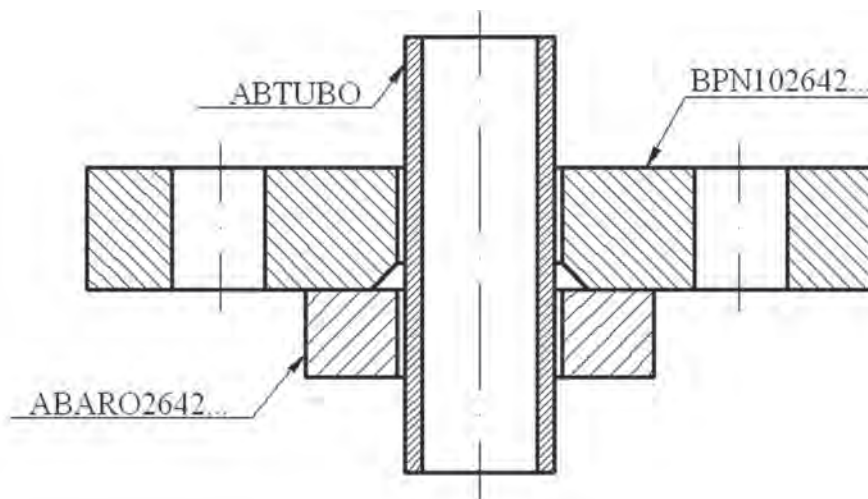

Manguera Inox, Racores y Bridas soldables

Tuyau Inox, raccords et brides à souder
Stainless steel hose, welding fittings and forged flanges
Tubi Inox, raccordi e flange a saldare

Brida loca DIN 2656 PN 40

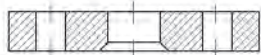

Bride plate tournante DIN 2656 PN 40 à souder
Swivel forged flange DIN 2656 PN 40
Flangia girevole a saldare DIN 2656 PN 40

DN	REFERENCIA PART N°	€
3/8"	BPN40265606	4,91
1/2"	BPN40265608	5,20
3/4"	BPN40265612	5,94
1"	BPN40265616	6,62
1" 1/4	BPN40265620	8,59
1" 1/2	BPN40265624	11,62
2"	BPN40265632	13,92
2" 1/2	BPN40265640	18,92
3"	BPN40265648	23,82
4"	BPN40265664	33,15

Tubo soldar brida ANSI-DIN



Tube à souder brides ANSI-DIN
Tube for welding flanges ANSI-DIN
Tubo per flangia a saldare ANSI-DIN

DN	REFERENCIA PART N°	€
3/8"	ABTUB006	1,74
1/2"	ABTUB008	1,83
3/4"	ABTUB012	2,31
1"	ABTUB016	3,07
1" 1/4	ABTUB020	3,76
1" 1/2	ABTUB024	4,62
2"	ABTUB032	6,14
2" 1/2	ABTUB040	6,51
3"	ABTUB048	7,88
4"	ABTUB064	12,00

Aro para brida DIN 2656

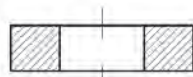

Collet épais pour brida DIN 2656
Ring for flange DIN 2656
Anello per flangia DIN 2656

DN	REFERENCIA PART N°	€
3/8"	ABARO265606	4,91
1/2"	ABARO265608	5,20
3/4"	ABARO265612	4,94
1"	ABARO265616	6,62
1" 1/4	ABARO265620	5,59
1" 1/2	ABARO265624	11,62
2"	ABARO265632	13,92
2" 1/2	ABARO265640	18,92
3"	ABARO265648	23,82

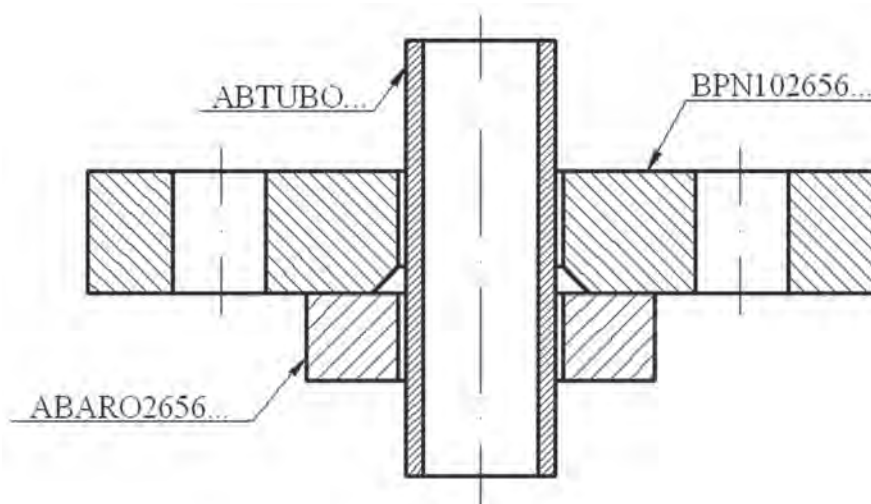

Manguera Inox, Racores y Bidas soldables

Tuyau Inox, raccords et brides à souder
Stainless steel hose, welding fittings and forged flanges
Tubi Inox, raccordi e flange a saldare

Hoses

Flexible hose fittings

Stainless steel hoses
and fittings

Low pressure

Air conditioned hoses
and fittings

Measuring flow

Machines for
mounting flexibles

Brida ANSI-ASA 150 LBS

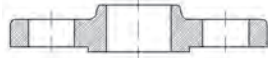

Bride tourn. ANSI-ASA 150 LBS
Swivel flange ANSI-ASA 150 LBS
Flangia ANSI-ASA 150 LBS

DN	REFERENCIA PART N°	€
1/2"	BANSASO15008	8,85
3/4"	BANSASO15012	9,20
1"	BANSASO15016	13,00
1" 1/4	BANSASO15020	18,71
1" 1/2	BANSASO15024	21,25
2"	BANSASO15032	25,14
2" 1/2	BANSASO15040	29,98
3"	BANSASO15048	37,98
4"	BANSASO15064	47,52

Aro para brida ANSI-ASA 150/300 LBS

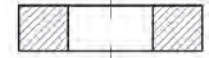

Collet épais pour bride ANSI-ASA
Tube for welding flanges ANSI-ASA
Anello per flangia ANSI-ASA 150/300 LBS

DN	REFERENCIA PART N°	€
1/2"	ABAROANSA08	3,22
3/4"	ABAROANSA12	3,76
1"	ABAROANSA16	5,10
1" 1/4	ABAROANSA20	5,74
1" 1/2	ABAROANSA24	7,71
2"	ABAROANSA32	11,03
2" 1/2	ABAROANSA40	15,08
3"	ABAROANSA48	19,37
4"	ABAROANSA64	23,68

Brida ANSI-ASA 300 LBS

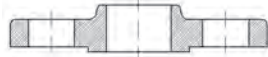

Bride tourn. ANSI-ASA 300 LBS
Swivel flange ANSI-ASA 300 LBS
Flangia ANSI-ASA 300 LBS

DN	REFERENCIA PART N°	€
1/2"	BANSASO30008	9,66
3/4"	BANSASO30012	13,65
1"	BANSASO30016	13,91
1" 1/4	BANSASO30020	20,01
1" 1/2	BANSASO30024	22,73
2"	BANSASO30032	26,40
2" 1/2	BANSASO30040	31,48
3"	BANSASO30048	39,88
4"	BANSASO30064	66,41

Tubo soldar brida ANSI-DIN



Tube à souder brides ANSI-DIN
Tube for welding flanges ANSI-DIN
Tubo per flangia a saldare ANSI-DIN

DN	REFERENCIA PART N°	€
3/8"	ABTUB006	1,74
1/2"	ABTUB008	1,83
3/4"	ABTUB012	2,31
1"	ABTUB016	3,07
1" 1/4	ABTUB020	3,76
1" 1/2	ABTUB024	4,62
2"	ABTUB032	6,14
2" 1/2	ABTUB040	6,51
3"	ABTUB048	7,88
4"	ABTUB064	12,00

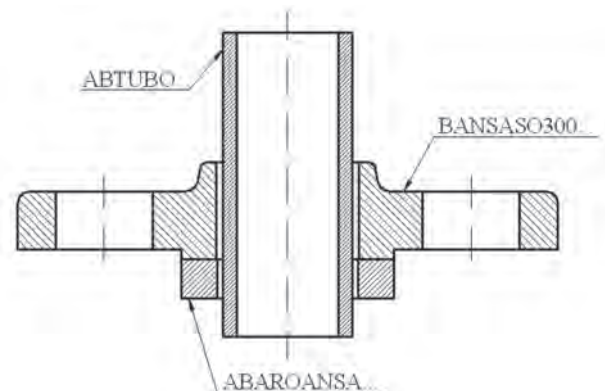
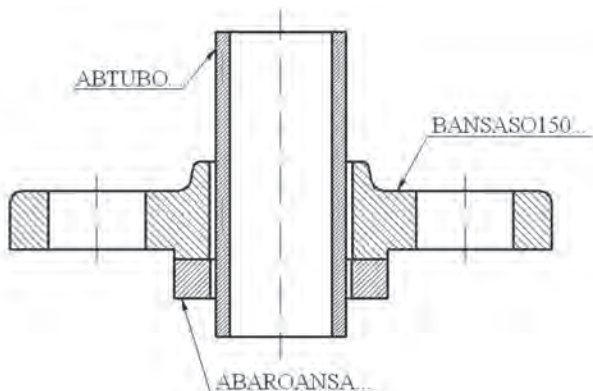

Inox coarrugado | Inox onduleux
Convoluté stainless steel | Inox corrugato



Baja presión

Basse pression

Low pressure

Tubi a bassa pressione

4

Manguera baja presión

Tuyau basse pression | Low pressure hose | Tubi bassa pressione

70

Racores baja presión

Raccords basse pression | Low pressure fittings | Raccordi bassa pressione

71

Manguera baja presión

Tuyau basse pression | Low pressure hose | Tubi bassa pressione

- ▶ **Mangueras de caucho sintético (gasoil)** | Tuyaux de caoutchouc synthétique (gas-oil) | Synthetic rubber hoses (diesel oil) | Tubi di caucciú sintético (diesel)

73



M100



M110

- ▶ **Mangueras serie L** | Tuyaux L series | Hoses L series | Tubo serie L

73



ML10

Racores baja presión

Raccords basse pression | Low pressure fittings | Raccordi bassa pressione

▶ Casquillos (campanillas) | Jupes basse pression | Sleeves | Boccole (in acciaio sottile)

74



A5010

▶ Conexiones BSP | Embouts BSP basse pression | BSP Fittings | Raccordi BSP

74



D5030



D5052



D5050



D5042



D5040



D5091

▶ Conexiones Métricas | Embouts Métriques basse pression | Metric fittings | Raccordi Metrici

76



D5070



D5082



D5080



D5090



D5062



D5060



D5085



D5020

Hoses

Flexible hose fittings

Stainless steel hoses and fittings

Low pressure

Air conditioned hoses and fittings

Measuring flow

Machines for mounting flexibles

Conexiones baja presión

Embouts basse pression | Low pressure fittings | Raccordi bassa pressione

Hoses

Flexible hose fittings

Stainless steel hoses
and fittings

Low pressure

- **Máquina prensar tubería baja presión. Ref. PMMBP** | Machine à sertir tuyaus basse pression
Machine to crimp low pressure hoses | Macchina pressatubi bassa pressione. Rif. PMMBP

Características | Caracteristiques | Features | Caratteristiche

- **Peso** | Poids | Weight | Peso: **22 kg.**
- **Medidas (mm)** | Mesures | Measures | Misure:
Máquina: Largo: 270 - Ancho: 130 - Alto: 260 | Machine: Long: 270 - Large: 130 - Haut: 260
Machine: Long: 270 - Wide: 130 - High: 260 | Macchina: Lunghezza: 270 - Larghezza: 130 - Altezza: 260
- **Palanca apriete: Ø 33 - Longitud: 750**
Levier: Ø 33 | Lever: Ø 33 | Leva: Ø 33
- **Tres juegos de grapas intercambiables** | 3 jeux de mors interchangeables
3 sets of interchangeable clamps | Tre serie di morsetti
- **Ø máx. de abertura** | Ø max. d'ouverture | Ø max. opening | Ø max. apertura: **56 mm.**
- **Ø máx. de campana** | Ø max. de jupe | Ø max. ferrule | Ø max. boccola: **40 mm.**
- **Ø ext. máx. de campana** | Ø ext. de jupe | Ø ext. ferrule | Ø esterno max. boccola: **40 mm.**
- **Ø ext. mín. de campana** | Ø ext. min. de jupe | Ø ext. min. ferrule | Ø esterno min. boccola: **10 mm.**
- **Ø de prensado según grapas mm.** | Ø sertissage selon mors mm
Crimping Ø According Clamps mm. | Ø di pressatura secondo morsetti mm.:
Grandes | Grandes | Big | Grande: **Máx. 37 - Mín. 21**
Medianas | Moyennes | Medium | Media: **Máx. 25 - Mín. 13**
Pequeñas | Petites | Small | Piccola: **Máx. 17 - Mín. 6**



- **Máquina prensar tubería baja presión. Ref. PMBP-HF** | Machien à sertir tuyaux basse pression
Machine to crimp low pressure hoses | Macchina pressatubi bassa pressione. Rif. PMBP-HF

Características | Caracteristiques | Features | Caratteristiche

- **Peso** | Poids | Weight | Peso: **40 kg.**
- **Medidas (mm)** | Mesures | Measures | Misure:
Máquina: Largo: 330 - Ancho: 130 - Alto: 740 | Machine: Long: 330 - Large: 130 - Haut: 740
Machine: Long: 330 - Wide: 130 - High: 740 | Macchina: Lunghezza: 330 - Larghezza: 130 - Altezza: 740
- **Dos posiciones de apriete** | 2 positions de sertissage
2 crimping positions | Due posizioni di chiusura
Hacia garras ①  ② Hacia manetas
Vers Mors | Vers Poignées
To Clamps | To Handles
Verso morsetto | Verso manopole
- **Dos juegos de grapas intercambiables** | 2 jeux de mors interchangeables
2 sets of interchangeable clamps | Due serie di morsetti
- **Apertura máx. con garras grandes** | Overture max. avec mors grands
Max. Opening with Big Clamps | Massima apertura con morsetto grande

	Pos. 1	Pos. 2
Máx.	41	37
Mín.	23	21
- **Apertura máx. con garras pequeñas** | Overture max. avec mors petits
Max. Opening with Small Clamps | Massima apertura con morsetto piccolo

	Pos. 1	Pos. 2
Máx.	31	26
Mín.	10	9



Air conditioned hoses
and fittings

Measuring flow

Machines for
mounting flexibles

Manguera baja presión

Tuyau basse pression
Low pressure hose
Tubi bassa pressione

Manguera de caucho sintético con una malla de acero galvanizado



Tuyau de caoutchouc synthétique avec une tresse d'acier galvanisé
Synthetic rubber hose with a galvanized steel braided
Tubo di caucciú sintético con una maglia di acciaio galvanizzato

Ø int	REFERENCIA PART N°	€
5	M10005	3,61
6	M10006	4,17
7	M10007	4,38
8	M10008	5,05
9	M10009	5,67
12	M10012	8,19
14	M10014	8,96
15	M10015	10,66
18	M10018	14,09
20	M10020	14,27
22	M10022	15,81
25	M10025	18,39
30	M10030	23,74
40	M10040	63,14
50	M10050	84,41

Manguera de caucho sintético con una malla textil de alta tenacidad



Tuyau de caoutchouc synthétique avec une tresse textil d'haute tenacité
Synthetic rubber hose with a textile braided high toughness
Tubo di caucciú sintético con una maglia tessile ad alta resistenza

Ø int	REFERENCIA PART N°	€
4	M11004	3,14
5	M11005	3,45
6	M11006	3,91
7	M11007	4,48
8	M11008	4,48
9	M11009	5,46
12	M11012	8,55

Manguera gasoil serie L



Tuyaux de NBR (gas-oil)
NBR hoses (diesel oil) L series
Tubo gasolio e Olio. Serie L

Ø int	REFERENCIA PART N°	€
6	ML10006	2,99
8	ML10008	3,29
10	ML10010	4,05
13	ML10013	6,75
16	ML10016	7,93

Racores baja presión

Raccords basse pression
Low pressure fittings
Raccordi bassa pressione

Hoses

Flexible hose fittings

Stainless steel hoses
and fittings

Low pressure

Air conditioned hoses
and fittings

Measuring flow

Machines for
mounting flexibles

Campanillas de plancha para manguera de baja presión



Jupes acier doux maleable pour tuyau basse pression

Sleeves for low pressure hose

Boccola in acciaio sottile per tubo bassa pressione

Ø int	REFERENCIA PART N°	€
10,5	A50101050000	0,29
12	A50101200000	0,31
13,5	A50101350000	0,32
14,5	A50101450000	0,33
15,5	A50101550000	0,35
17	A50101700000	0,42
18,5	A50101850000	0,43
20,5	A50102050000	0,52
22,5	A50102250000	0,60
24,5	A50102450000	0,69
26	A50102600000	0,80
28	A50102800000	0,85
30	A50103000000	0,99
33	A50103300000	1,07
35	A50103500000	1,25
42	A50104200000	3,67
56	A50105600000	5,68
61	A50106100000	6,01
71	A50107100000	6,93

Tuerca BSP



Ecrou BSP

BSP Nut

Dado BSP

ROSCA THREAD	REFERENCIA PART N°	€
1/4" BSP	D50300400000	0,63
3/8" BSP	D50300600000	0,70
1/2" BSP	D50300800000	1,01
3/4" BSP	D50301200000	1,46
1" BSP	D50301600000	2,40
1" 1/4 BSP	D50302000000	6,39
1" 1/2 BSP	D50302400000	7,53
2" BSP	D50303200000	12,90

Boquilla asiento cónico 60° (BSP) baja presión



Nipple embout femelle BSP 60° basse pression

BSP Nipple 60° cone low pressure

Inserto cono 60° BSP bassa pressione

TUBO PIPE	TUERCA NUT	REFERENCIA PART N°	€
5-6	1/4"	D50520405000	0,87
7-8	1/4"	D50520407000	0,76
7-8	3/8"	D50520607000	1,05
9-10	3/8"	D50520609000	0,82
12-13	1/2"	D50520812000	0,89
15-16	1/2"	D50520815000	0,89
15-16	3/4"	D50521216000	1,43
19-20	3/4"	D50521220000	1,33
19-20	1"	D50521620000	3,35
25	1"	D50521625000	2,78
30	1" 1/4	D50522030000	5,69
40	1" 1/2	D50522440000	9,30
50	2"	D50523250000	15,50

Racores baja presión

Raccords basse pression
Low pressure fittings
Raccordi bassa pressione

Boquilla asiento plano (BSP) baja presión



Nipple embout femelle fond plat BSP basse pression
BSP Nipple flat seat
Inserto faccia piana BSP bassa pressione

TUBO PIPE	TUERCA NUT	REFERENCIA PART N°	€
5-6	1/4"	D50500405000	1,14
7-8	1/4"	D50500407000	1,12
9-10	3/8"	D50500609000	1,20
12-13	1/2"	D50500812000	1,14
15-16	1/2"	D50500815000	1,33
15-16	3/4"	D50501216000	1,64
19-20	3/4"	D50501220000	1,68
19-20	1"	D50501620000	3,68
25	1"	D50501625000	3,44
30	1" 1/4	D50502030000	6,87
40	1" 1/2	D50502440000	12,63
50	2"	D50503250000	19,57

Macho BSP rosca cilíndrica asiento cónico 60°



Embout mâle fixe BSP cone 60° basse pression
BSP Cylindrical male low pressure 60° cone
Maschio BSP cilindrico sede conica 60° bassa pressione

TUBO PIPE	ROSCA THREAD	REFERENCIA PART N°	€
5-6	1/4"	D50420405000	1,41
7-8	1/4"	D50420407000	1,96
7-8	3/8"	D50420607000	1,87
9-10	3/8"	D50420609000	2,06
12-13	3/8"	D50420612000	2,08
12-13	1/2"	D50420812000	0,89
15-16	1/2"	D50420815000	2,32
15-16	3/4"	D50421216000	3,39
19-20	3/4"	D50421220000	3,04
19-20	1"	D50421620000	3,81
25	1"	D50421625000	4,81
30	1" 1/4	D50422030000	15,13
40	1" 1/2	D50422440000	19,23
50	2"	D50423250000	27,58

Macho BSP rosca cilíndrica asiento plano



Embout mâle gaz fond plat basse pression
Low pressure BSP cylindrical male flat seat
Maschio BSP cilindrico sede piana bassa pressione

TUBO PIPE	ROSCA THREAD	REFERENCIA PART N°	€
5-6	1/8"	D50400205000	1,38
5-6	1/4"	D50400405000	2,06
7-8	1/4"	D50400407000	1,88
7-8	3/8"	D50400607000	2,14
9-10	3/8"	D50400609000	2,10
12-13	1/2"	D50400812000	2,55
15-16	1/2"	D50400815000	2,55
15-16	3/4"	D50401216000	3,88
19-20	3/4"	D50401220000	3,70
19-20	1"	D50401620000	5,90
25	1"	D50401625000	5,10
30	1" 1/4	D50402030000	17,31
40	1" 1/2	D50402440000	24,40
50	2"	D50403250000	28,12

Codo 90° baja gas cono 60°



Embout femelle 90° gaz cyl BSP 60° basse pression
90° BSP Swivel female 60° cone low pressure
Femmina a 90° sede 60° bassa pressione

TUBO PIPE	ROSCA THREAD	REFERENCIA PART N°	€
5-6	1/4"	D50910405000	3,84
7-8	1/4"	D50910407000	4,16
7-8	3/8"	D50910607000	4,19
9-10	3/8"	D50910609000	5,48
12-13	1/2"	D50910812000	6,18
15-16	1/2"	D50910815000	5,92
15-16	3/4"	D50911216000	10,97
19-20	3/4"	D50911220000	10,97
19-20	1"	D50911620000	16,02
25	1"	D50911625000	16,76
30	1" 1/4	D50912030000	27,48
40	1" 1/2	D50912440000	54,89
50	2"	D50913250000	114,32

Racores baja presión

Raccords basse pression
Low pressure fittings
Raccordi bassa pressione

Tuerca Métrica



Écrou métrique
Metric nut
Dado Metrico

ROSCA THREAD	REFERENCIA PART N°	€
M10X1	D50701000000	0,70
M12X1,5	D507012000000	0,69
M14X1,5	D507014000000	0,90
M16X1,5	D507016000000	1,42
M18X1,5	D507018000000	1,80
M22X1,5	D507022000000	1,55
M26X1,5	D507026000000	1,88

Boquilla en codo 90° asiento cónico 60° (métrico) baja presión



Nipple en embout femelle 90° din métrique cone 60° basse pression
Nipple in 90° metric swivel female tapered seat low pressure
Femmina a 90° Metrica sede conica 60°

TUBO PIPE	ROSCA THREAD	REFERENCIA PART N°	€
5-6	10X1	D50901006000	4,92
7-8	12X1,5	D50901207000	5,40
9-10	14X1,5	D50901409000	5,84
9-10	16X1,5	D50901609000	6,86
9-10	18X1,5	D50901810000	6,86
15-16	22X1,5	D50902215000	6,86
15-16	26X1,5	D50902615000	13,31

Boquilla asiento cónico 60° (Métrica) baja presión



Nipple pour embout femelle din métrique cone 60° basse pression
Metric nipple 60° cone low pressure
Inserto cono 60° Metrico bassa pressione

TUBO PIPE	TUERCA NUT	REFERENCIA PART N°	€
5-6	10X1	D50821005000	1,16
7-8	12X1,5	D50821207000	0,91
9-10	14X1,5	D50821409000	1,25
9-10	18X1,5	D50821810000	1,48
12-13	22X1,5	D50822212000	1,75
15-16	22X1,5	D50822215000	1,67
12-13	26X1,5	D50822612000	2,50
15-16	26X1,5	D50822615000	2,05

Macho rosca Métrica asiento cónico 60° baja presión



Embout mâle din métrique cone 60° basse pression
Metric cylindrical male 60° cone
Maschio Metrico sede conica 60° bassa pressione

TUBO PIPE	ROSCA THREAD	REFERENCIA PART N°	€
5-6	10X1	D50621005000	1,39
7-8	12X1,5	D50621207000	1,75
9-10	14X1,5	D50621409000	2,24
9-10	16X1,5	D50621609000	2,00
12-13	16X1,5	D50621612000	2,00
9-10	18X1,5	D50621810000	2,75
12-13	22X1,5	D50622212000	3,75
15-16	22X1,5	D50622215000	3,03
12-13	26X1,5	D50622612000	4,35
15-16	26X1,5	D50622615000	4,35

Boquilla asiento plano (Métrica) baja presión



Nipple pour embout femelle métrique fond plat basse pression
Metric nipple flat seat low pressure
Inserto faccia piana bassa pressione

TUBO PIPE	TUERCA NUT	REFERENCIA PART N°	€
5-6	10X1	D50801005000	1,28
7-8	12X1,5	D50801207000	1,34
9-10	14X1,5	D50801409000	1,34
9-10	16X1,5	D50801609000	1,34
9-10	18X1,5	D50801810000	1,34
12-13	22X1,5	D50802212000	1,59
15-16	22X1,5	D50802215000	1,59
12-13	26X1,5	D50802612000	2,50
15-16	26X1,5	D50802615000	1,83

Macho rosca Métrica asiento plano baja presión



Embout mâle métrique fond plat basse pression
Metric cyl male flat seat low pressure
Maschio Metrico sede piana bassa pressione

TUBO PIPE	ROSCA THREAD	REFERENCIA PART N°	€
5-6	10X1	D50601005000	1,93
7-8	12X1,5	D50601207000	2,39
9-10	14X1,5	D50601409000	2,18
9-10	16X1,5	D50601609000	2,75
12-13	16X1,5	D50601612000	2,60
9-10	18X1,5	D50601810000	3,07
12-13	22X1,5	D50602212000	2,45
15-16	22X1,5	D50602215000	2,45
12-13	26X1,5	D50602612000	4,35
15-16	26X1,5	D50602615000	4,35

Racores baja presión

Raccords basse pression
Low pressure fittings
Raccordi bassa pressione

Espiga lisa Métrica baja presión



Embout lisse métrique basse pression
Metric standpipe low pressure
Estremitá tubolare Metrica bassa pressione

TUBO PIPE		REFERENCIA PART N°	€
5-6	4	D50850405000	4,08
5-6	6	D50850606000	2,17
5-6	8	D50850806000	2,17
7-8	8	D50850808000	2,58
7-8	10	D50851008000	2,33
9-10	10	D50851010000	2,33
12-13	12	D50851212000	2,48
15-16	15	D50851515000	3,98
15-16	18	D50851815000	4,44

Orientable métrico baja presión



Embout banjo métrique basse pression
Low pressure metric banjo
Raccordo ad occhio Metrico bassa pressione

TUBO PIPE	Ø	REFERENCIA PART N°	€
5-6	8	D50200805	2,76
7-8	8	D50200807	2,76
5-6	10	D50201005	3,19
7-8	10	D50201007	2,90
9-10	10	D50201009	3,25
5-6	12	D50201205	3,25
7-8	12	D50201207	3,20
9-10	12	D50201209	3,20
5-6	14	D50201405	3,25
7-8	14	D50201407	3,25
9-10	14	D50201409	2,73

Aire acondicionado

Climatisation

Air conditioned hoses and fittings

Aria condizionata

Mangueras

Tuyaux | Hoses | Tubi

Hoses

Flexible hose fittings

Stainless steel hoses and fittings

Low pressure

Air conditioned hoses and fittings

Measuring flow

Machines for mounting flexibles



Mangueras Freón Barrier N (polivalente) Freón 134, 12, 14... | Tuyaux Freon Barrier N (Polyvalent) Freón 134, 12, 14... | Air Conditioned Barrier N Hose | Tubo Freón Barrier N (polivalente) Freón 134, 12, 14...

Tubo Tuyau DN Hose Tubi	Galga Pige Gauge Size	Referencia Référence Part No. Codice	€
BARRIER N 5/16	6	M520006	11,88
BARRIER N 13/32	8	M520008	13,97
BARRIER N 1/2	10	M520010	15,91
BARRIER N 5/8	12	M520012	17,46

▶ **Está compuesta por dos capas de caucho NBR con una fina capa de nylon entre ellas. Una malla textil resistente al calor y elementos químicos. Cubierta exterior de EPDM.**

Ce tuyau est compose par deux nappes de caoutchouc NBR avec une fine nappe de nylon entre elles. Une trece textile qui resiste le chaleur el éléments chimiques. Revêtement extérieur d'EPDM.

This hose is manufactured with a thin nylon layer between two layers of rubber NBR. One braid of heat and chemical resistant textile reinforcement. Outer cover of EPDM.

É composto da due strati di gomma NBR con un sottile strato di nylon nel mezzo. Una maglia tessile resistente al calore e agli elementi chimici. Rivestimento esterno di EPDM.

Aplicaciones | Applications | Applicazioni

Utilización con refrigerantes HFC-134a y CFC-12 | Utilisation avec refrigerants HFC-134a et CFC-12
Using with refrigerants HFC-134a and CFC-12 | Utilizzo con refrigeranti HFC-134a e CFC-12

Temperatura de trabajo | Temperature de service | Working pressure | Temperatura di lavoro

-30 / 125 °C

DN		5/16" (8 mm)	13/32" (10 mm)	1/2" (13 mm)	5/8" (16 mm)
Diámetro interior Diamètre intérieur Inner diameter Diametro interno	(in)	0.322	0.418	0.512	0.637
	(mm)	8.2	10.6	13	16.2
Diámetro exterior Diamètre extérieur Outer diameter Diametro esterno	(in)	0.750	0.906	1	1.125
	(mm)	19.1	23	25.4	28.6
Presión de rotura Pression de rupture Burst pressure Pressione di rotura	(psi)	2000	2000	2000	1750
	(bar)	140	140	140	122

▶ **Presna manual** | Presse manuel | Manual Press Machine | Pressa manuale

Presna Freón. Ref. V001040 (sin juegos de mordazas)
| Presse Freon. Ref. V001040 | Crimping machine for air conditioned hose | Presse Freon Rif. V001040 (senza serie di morsetti)

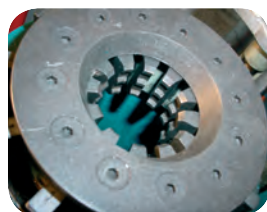
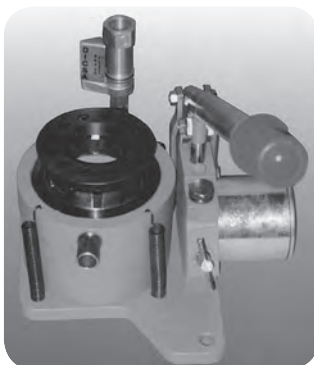







▶ **Presnas eléctricas** | Presse électrique | Electric Press Machine | Pressa elettriche



Disponemos de garras de freón para las presnas SE 25 - PE 25 / 32 / 38 / 50 / 4-50 - PE 180 - PES 50... | Nous avons mors de freon pour les presses SE 25 - PE 25 / 32 / 38 / 50 / 4-50 - PE 180 - PES 50... | We have air-conditioned clamps for the following machines SE 25 - PE 25 / 32 / 38 / 50 / 4-50 - PE 180 - PES 50... | Disponiamo di morsetti da Freon per le presse SE25 - PE 25 / 32 / 38 / 50 / 4-50 - PE 180 - PES 50...

Racores aire acondicionado

Raccords climatisation | Air conditioned fittings | Raccordi aria condizionata

- | | |
|--|----|
| ▶ Rotalock sin válvula Raccords Rotalock sans vanne Rotalock without valve Raccordi Rotalock senza valvola | 83 |
|  <p data-bbox="227 450 882 477">FXR FX90 FX45 FXA90</p> | |
| ▶ Rotalock con válvula Raccords Rotalock avec vanne Rotalock with valve Raccordi Rotalock con valvola | 83 |
|  <p data-bbox="227 692 882 719">FXRV FX45V FX90V FXAV90</p> | |
| ▶ Racores de unión Raccord union climatisation Couplings Raccordi di unione | 84 |
|  <p data-bbox="204 934 475 960">134 URTV URT</p> | |
| ▶ Hembras con junta tórica sin válvula Femelles climatisation tournantes avec joint vert sans vanne Swivel female with green joint Femmine con o'ring senza valvola | 84 |
|  <p data-bbox="227 1171 678 1198">FOR FO45 FO90</p> | |
| ▶ Hembras con junta tórica con válvula Femelles climatisation tournantes avec joint vert et avec vanne Swivel female with green joint with valve Femmine con o'ring e valvola | 84 |
|  <p data-bbox="227 1413 678 1440">FORV FO90V FO45V</p> | |
| ▶ Machos con junta tórica Mâles climatisation avec joint vert Males with green joint Maschi con o'ring | 85 |
|  <p data-bbox="227 1655 678 1682">MOR MO45 MO90</p> | |
| ▶ Adaptadores Adapteurs climatisation pour Freón Adaptors Adattatori | 85 |
|  <p data-bbox="227 1888 485 1915">BRV BORV</p> | |

▶ **Conexiones rosca SAE** | Femelles climatisation tournantes SAE | Swivel females SAE | Raccordi SAE

86



FSR



FS90



FS45

▶ **Conexiones con válvula para Freón 12** | Embouts climatisation pour Freón 12 avec vanne | Fittings with valve for air conditioned 12 | Raccordi con valvola per Freon 12

86



FXRV



FXAV90



URTV



FX90V

▶ **Juntas tóricas para racores Freón 134** | Joints toriques spéciaux pour Freón 134 | Joints for air conditioned 134 fittings | O'rings per raccordi per Freon 134

87



* FREON

▶ **Racores recuperables** | Raccords climatisation récupérables | Reusable fittings | Raccordi recuperabili

87



CRF

Racores aire acondicionado

Raccords climatisation
Air conditioned fittings
Raccordi aria condizionata

Hembra recta con junta Rotalock



Femelle climatisation droite Rotalock avec raccord tube "o" compresseur
Straight female with Rotalock joint
Femmina diritta con guarnizione Rotalock

DN	ROSCA THREAD	REFERENCIA PART N°	€
13/32"	1" 14h UNS	FXR 1108	10,92
1/2"	1" 14h UNS	FXR 1110	11,31
5/8"	1" 14h UNS	FXR 1112	22,48

Hembra 90° con junta Rotalock



Femelle climatisation 90° Rotalock avec raccord tube 90° "o" compresseur
90° Female with Rotalock joint
Femmina a 90° con guarnizione Rotalock

DN	ROSCA THREAD	REFERENCIA PART N°	€
13/32"	1" 14h UNS	FX90 1108	12,22
1/2"	1" 14h UNS	FX90 1110	13,00
5/8"	1" 14h UNS	FX90 1112	18,58

Hembra recta con junta Rotalock y válvula 134



Femelle droite Rotalock avec joint et vanne pour 134
Straight female with Rotalock joint and 134 valve
Femmina diritta con guarnizione Rotalock e valvola 134

DN	ROSCA THREAD	REFERENCIA PART N°	€
13/32"	1" 14h UNS	134 FXRV 1108	19,88
1/2"	1" 14h UNS	134 FXRV 1110	20,40
5/8"	1" 14h UNS	134 FXRV 1112	22,48

Hembra 45° con junta Rotalock y válvula 134



Femelle 45° Rotalock avec joint et vanne pour 134
45° Female with Rotalock joint and 134 valve
Femmina a 45° con guarnizione Rotalock e valvola 134

DN	ROSCA THREAD	REFERENCIA PART N°	€
13/32"	1" 14h UNS	134 FX45V 1108	22,22
1/2"	1" 14h UNS	134 FX45V 1110	21,31

Hembra 45° con junta Rotalock



Femelle climatisation 45° Rotalock avec raccord tube 45° "o" compresseur
45° Female with Rotalock joint
Femmina a 45° con guarnizione Rotalock

DN	ROSCA THREAD	REFERENCIA PART N°	€
13/32"	1" 14h UNS	FX45 1108	12,09
1/2"	1" 14h UNS	FX45 1110	13,00
5/8"	1" 14h UNS	FX45 1112	18,45

Hembra especial 90° con junta Rotalock



Femelle climatisation spéciale 90° rotalock avec raccord tube 90° spécial "o" compresseur
90° Special female with Rotalock joint
Femmina a 90° speciale con guarnizione Rotalock

DN	ROSCA THREAD	REFERENCIA PART N°	€
13/32"	1" 14h UNS	FXA90 1108	19,10
1/2"	1" 14h UNS	FXA90 1110	19,36

Hembra 90° con junta Rotalock y válvula 134



Femelle 90° Rotalock avec joint et vanne pour 134
90° Female with Rotalock joint and 134 valve
Femmina a 90° con guarnizione Rotalock e valvola 134

DN	ROSCA THREAD	REFERENCIA PART N°	€
13/32"	1" 14h UNS	134 FX90V 1108	20,92
1/2"	1" 14h UNS	134 FX90V 1110	21,44
5/8"	1" 14h UNS	134 FX90V 1112	24,82

Hembra especial 90° con junta Rotalock y válvula 134



Femelle climatisation spéciale 90° Rotalock avec joint et vanne pour 134
90° special Female with Rotalock joint and 134 valve
Femmina a 90° speciale con guarnizione Rotalock e valvola 134

DN	ROSCA THREAD	REFERENCIA PART N°	€
13/32"	1" 14h UNS	134 FXAV90 1108	25,47
1/2"	1" 14h UNS	134 FXAV90 1110	25,73

Racores aire acondicionado

Raccords climatisation
Air conditioned fittings
Raccordi aria condizionata

Hoses

Racor de unión con válvula 134



Raccord d'union climatisation avec vanne pour splicer vanne pour r134
134 valve coupling
Raccordo di unione tubi con valvola 134

DN	REFERENCIA PART N°	€
5/16"	134 URTV 0006	20,14
13/32"	134 URTV 0008	21,44
1/2"	134 URTV 0010	21,57
5/8"	134 URTV 0012	21,83

Flexible hose fittings

Racor de unión



Raccord d'union climatisation splicer
Hose-hose coupling
Raccordo di unione tubo-tubo

DN	REFERENCIA PART N°	€
5/16"	URT 0006	9,23
13/32"	URT 0008	9,49
1/2"	URT 0010	10,79
5/8"	URT 0012	11,31

Stainless steel hoses
and fittings

Hembra giratoria recta con junta verde



Femelle climatisation tournante avec joint vert
Straight swivel female with green joint
Femmina diritta con o'ring verde

DN	ROSCA THREAD	REFERENCIA PART N°	€
5/16"	5/8" 18h UNF	FOR 0606	7,67
13/32"	3/4" 16h UNF	FOR 0808	8,19
1/2"	7/8" 14h UNF	FOR 1010	9,36
5/8"	7/8" 14h UNF	FOR 1012	10,40
5/8"	1" 1/16 12h UNF	FOR 1212	12,35

Low pressure

Hembra giratoria 90° con junta verde



Femelle climatisation tournante 90° avec joint vert
90° swivel female with green joint
Femmina a 90° con o'ring verde

DN	ROSCA THREAD	REFERENCIA PART N°	€
5/16"	5/8" 18h UNF	FO90 0606	8,71
13/32"	3/4" 16h UNF	FO90 0808	9,23
1/2"	7/8" 14h UNF	FO90 1010	10,01
5/8"	7/8" 14h UNF	FO90 1012	10,92
5/8"	1" 1/16 12h UNF	FO90 1212	13,26

Hembra giratoria 45° con junta verde



Femelle climatisation tournante 45° avec joint vert
45° swivel female with green joint
Femmina a 45° con o'ring verde

DN	ROSCA THREAD	REFERENCIA PART N°	€
5/16"	5/8" 18h UNF	FO45 0606	8,45
13/32"	3/4" 16h UNF	FO45 0808	9,23
1/2"	7/8" 14h UNF	FO45 1010	10,01
5/8"	7/8" 14h UNF	FO45 1012	10,92
5/8"	1" 1/16 12h UNF	FO45 1212	13,26

Air conditioned hoses
and fittings

Measuring flow

Hembra orientable recta con válvula



Femelle climatisation tournante avec joint vert et vanne pour 134
Straight swivel female with green joint and valve
Femmina diritta con o'ring verde e valvola 134

DN	ROSCA THREAD	REFERENCIA PART N°	€
5/16"	5/8" 18h UNF	FORV 0606	16,63
13/32"	3/4" 16h UNF	FORV 0808	17,15
1/2"	7/8" 14h UNF	FORV 1010	17,67
5/8"	7/8" 14h UNF	FORV 1012	18,71
5/8"	1" 1/16 12h UNF	FORV 1212	21,18

Machines for
mounting flexibles

Hembra orientable 90° con válvula



Femelle climatisation tournante 90° avec joint vert et vanne pour 134
90° Swivel female with green joint and valve
Femmina a 90° con o'ring verde e valvola 134

DN	ROSCA THREAD	REFERENCIA PART N°	€
5/16"	5/8" 18h UNF	FO90V 0606	18,45
13/32"	3/4" 16h UNF	FO90V 0808	19,23
1/2"	7/8" 14h UNF	FO90V 1010	19,36
5/8"	7/8" 14h UNF	FO90V 1012	19,36
5/8"	1" 1/16 12h UNF	FO90V 1212	23,39

Racores aire acondicionado

Raccords climatisation
Air conditioned fittings
Raccordi aria condizionata

Hembra orientable 45° con válvula



Femelle climatisation tournante 45° avec joint vert et vanne pour 134
45° Swivel female with green joint and valve
Femmina a 45° con o'ring verde e valvola 134

DN	ROSCA THREAD	REFERENCIA PART N°	€
5/16"	5/8" 18h UNF	FO45V 0606	17,54
13/32"	3/4" 16h UNF	FO45V 0808	18,32
1/2"	7/8" 14h UNF	FO45V 1010	18,71
5/8"	7/8" 14h UNF	FO45V 1012	19,36
5/8"	1" 1/16 12h UNF	FO45V 1212	23,26

Macho recto con junta tórica



Mâle climatisation tournant avec joint vert
Straight male with green joint
Maschio diritto con o'ring

DN	ROSCA THREAD	REFERENCIA PART N°	€
5/16"	5/8" 18h UNF	MOR 0606	7,67
13/32"	3/4" 16h UNF	MOR 0808	8,19
1/2"	7/8" 14h UNF	MOR 1010	9,75
5/8"	7/8" 14h UNF	MOR 1012	11,23
5/8"	1" 1/16 12h UNF	MOR 1212	12,61

Macho 90° con junta tórica



Mâle climatisation tournant 90° avec joint vert
90° Male with green joint
Maschio a 90° con o'ring

DN	ROSCA THREAD	REFERENCIA PART N°	€
5/16"	5/8" 18h UNF	MO90 0606	8,71
13/32"	3/4" 16h UNF	MO90 0808	9,36
1/2"	7/8" 14h UNF	MO90 1010	10,66
5/8"	7/8" 14h UNF	MO90 1012	11,96
5/8"	1" 1/16 12h UNF	MO90 1212	13,77

Macho 45° con junta tórica



Mâle climatisation tournant 45° avec joint vert
45° Male with green joint
Maschio a 45° con o'ring

DN	ROSCA THREAD	REFERENCIA PART N°	€
5/16"	5/8" 18h UNF	MO45 0606	8,71
13/32"	3/4" 16h UNF	MO45 0808	9,23
1/2"	7/8" 14h UNF	MO45 1010	10,40
5/8"	7/8" 14h UNF	MO45 1012	11,96
5/8"	1" 1/16 12h UNF	MO45 1212	13,64

Adaptador en codo con val. macho (para hembra con junta) - hembra Rotalock



Adaptateur climatisation coude compact mâle-femelle Rotalock avec vanne
Elbow adaptor with male valve - Rotalock female
Adattatore a 90° con valvola maschio (per femmina con guarnizione) - femmina Rotalock

ROSCA THREAD	REFERENCIA PART N°	€	
1" 14h UNS	M 3/4" 16h UNF	BRV 0808	19,75
1" 14h UNS	M 7/8" 14h UNF	BRV 1010	19,99

Adaptador en codo con val. macho (para hembra SAE) - hembra Rotalock



Adaptateur climatisation coude compact mâle (pour femelle SAE) x femelle Rotalock avec vanne
Elbow adaptor with male valve SAE - Rotalock female
Adattatore a 90° con valvola maschio (per femmina SAE) - femmina Rotalock

ROSCA THREAD	REFERENCIA PART N°	€	
1" 14h UNS	M 3/4" 16h UNF	BORV 0808	17,56
1" 14h UNS	M 7/8" 14h UNF	BORV 1010	17,71

Racores aire acondicionado

Raccords climatisation
Air conditioned fittings
Raccordi aria condizionata

Hoses

Hembra giratoria recta



Femelle climatisation tournante SAE droite
Straight swivel female SAE
Femmina diritta SAE

DN	ROSCA THREAD	REFERENCIA PART N°	€
5/16"	5/8" 18h UNF	FSR 0606	10,14
13/32"	3/4" 16h UNF	FSR 0808	11,05
1/2"	7/8" 14h UNF	FSR 1010	12,35

Codo 45° hembra giratoria



Femelle climatisation tournante 45° SAE
45° Swivel female SAE
Femmina a 45° SAE

DN	ROSCA THREAD	REFERENCIA PART N°	€
5/16"	5/8" 18h UNF	FS45 0606	10,92
13/32"	3/4" 16h UNF	FS45 0808	12,22
1/2"	7/8" 14h UNF	FS45 1010	13,00

Flexible hose fittings

Codo 90° hembra giratoria



Femelle climatisation tournante 90° SAE
90° Swivel female SAE
Femmina a 90° SAE

DN	ROSCA THREAD	REFERENCIA PART N°	€
5/16"	5/8" 18h UNF	FS90 0606	11,05
13/32"	3/4" 16h UNF	FS90 0808	12,22
1/2"	7/8" 14h UNF	FS90 1010	13,13

Stainless steel hoses
and fittings

Low pressure

Hembra recta con junta Rotalock y válvula



Femelle climatisation droite Rotalock avec joint et vanne pour R12
Straight female with Rotalock joint and valve
Femmina diritta con guarnizione Rotalock e valvola

DN	ROSCA THREAD	REFERENCIA PART N°	€
13/32"	1" 14h UNS	FXRV 1108	17,15
1/2"	1" 14h UNS	FXRV 1110	8,19

Racor de unión con válvula



Raccord union avec vanne pour R14 splicer vanne pour R12
Union fitting with valve
Raccordi de unione con valvola

DN	REFERENCIA PART N°	€
5/16"	URTV 0006	15,07
13/32"	URTV 0008	15,46
1/2"	URTV 0010	15,98

Air conditioned hoses
and fittings

Measuring flow

Hembra especial 90° con junta Rotalock y válvula



Femelle climatisation spéciale 90° Rotalock avec joint et vanne pour R12
90° Special female with Rotalock joint and valve
Femmina a 90° speciale con guarnizione Rotalock e valvola

DN	ROSCA THREAD	REFERENCIA PART N°	€
13/32"	1" 14h UNS	FXAV90 1108	24,69
1/2"	1" 14h UNS	FXAV90 1110	24,95

Hembra 90° con junta Rotalock y válvula



Femelle climatisation 90° Rotalock avec joint et vanne pour R12
90° Female with Rotalock joint and valve
Femmina a 90° con guarnizione Rotalock e valvola

DN	ROSCA THREAD	REFERENCIA PART N°	€
13/32"	1" 14h UNS	FX90V 1108	18,84
1/2"	1" 14h UNS	FX90V 1110	19,75

Machines for
mounting flexibles

Racores aire acondicionado

Raccords climatisation
Air conditioned fittings
Raccordi aria condizionata

Junta tórica para racores Freón 134



Joint torique spécial pour Freon 134
Joints for air conditioned 134 fittings
O'ring per raccordi per Freon 134

DN	REFERENCIA PART N°	€
5/16	7.65X1.78 FREON	0,67
13/32	10.82X1.78 FREON	0,76
1/2	14X1.78 FREON	0,95
5/8	18.77X1.78 FREON	1,19

Racores recuperables cargadoras



Raccords climatisation récupérables pour chargeurs
Reusable fittings for loaders
Raccordi recuperabili per carico

DN	ROSCA THREAD	Descripción Description	REFERENCIA PART N°	€
3/16"	7/16"	H.G. 90°	CRFC900703	13,33
3/16"	7/16"	Casquillo	CRFM003	4,05
3/16"	7/16"	H.G. Recta	CRFTL0703	5,45

Para manguera Barrier // Pour tuyaux Barrier // For Barrier hose // Per tubi Barrier

Hoses

Flexible hose fittings

Stainless steel hoses
and fittings

Low pressure

Air conditioned hoses
and fittings

Measuring flow

Machines for
mounting flexibles

Metrología

Test du circuit hydraulique

Measuring flow

Test del circuito idraulico

6

Racores de control	90
Prise de control Checking fittings Prese di pressione	
Tomas de manómetros	91
Embouts manomètres Manometers fittings Raccordi per manometri	
Manómetros y vacuómetros	92
Manomètres et vacuomètres Manometers and vacuum gauges Manometri e vacuometri	
Medidores de caudal	93
Debimètres Flow tester Indicatori di flusso	

Racores de control

Prise de control | Checking fittings | Prese di pressione

Hoses

Flexible hose fittings

Stainless steel hoses and fittings

Low pressure

Air conditioned hoses and fittings

Measuring flow

Machines for mounting flexibles

▶ Tomas de presión 16x2 | Prises de pression 16x2 | Check couplings for manometers 16x2 | Prese di pressione 16x2

95



MPR C/J



MPR G



MPR BSPT



MPR NPT



MPR M



MPR A



MPR TUB



MPR UNF



MPR TLM CM



MPR M CM

▶ Accesorios / adaptadores | Accessoires / adapteurs minimes | Accessoires / adaptors | Accessori / adattatori

96



MPR PT BSP



MPD BSP



MPD 90 BSP



27C/28C



MPR PT

Tomas de manómetros

Embouts manomètres | Manometers fittings | Raccordi per manometri

▶ Mangueras para tomas de manómetro | Tuyaux capiler minimesse | Hoses for check couplings for manometers | Tubi per prese di pressione

97



M089K

▶ Conexiones para prensar | Embouts à sertir minimesse | Crimp fittings | Raccordi a pressare

97

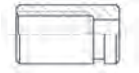

55501



55506

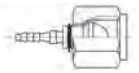

55504

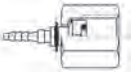

55505

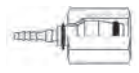

5550795



55503



55507



55517



55509



55508



54000



55513

Hoses

Flexible hose fittings

Stainless steel hoses and fittings

Low pressure

Air conditioned hoses and fittings

Measuring flow

Machines for mounting flexibles

Manómetros y vacuómetros

Manomètres et vacuomètres | Manometers and vacuum gauges | Manometri e vacuometri

Hoses

▶ Manómetros | Manomètres | Manometers | Manometri

99



MFI63...V



MFI63...-DB



MFI100...V



MFI100...-DB



MFI CO

Flexible hose fittings

▶ Vacuómetros | Vacuomètres | Vacuum gauges | Vacuometri

100



VAC6304



MFI VA

Stainless steel hoses
and fittings

▶ Equipos de medición | Équipements de mesure | Check cases | Valigetta per rilevamento di pressione

100



CBOXMED 3



CBOXMED 4



CBOXMED F

Low pressure

Air conditioned hoses
and fittings

Measuring flow

Machines for
mounting flexibles

Medidores de caudal

Debimètres | Flow tester | Indicatori di flusso

▶ Caudalímetros 250 bar | Debimètres 250 bar | Flow tester 250 bar | Flussostati 250 bar 101



WPB3A6H WPB4A6H WPB5A6H

▶ Caudalímetros 300-400 bar | Debimètres 300-400 bar | Flow tester 300-400 bar | Flussostati 300-400 bar 101



FT5758 FT6068 FT5594

▶ Foto-tacómetro | Photo-tachymètre | Photo-tachometer | Foto-tachimetro 101



DT

Hoses

Flexible hose fittings

Stainless steel hoses and fittings

Low pressure

Air conditioned hoses and fittings

Measuring flow

Machines for mounting flexibles

Racores de control

Prise de control
Checking fittings
Prese di pressione

Racor de control rosca BSP con junta tórica



Prise de pression avec o'ring capouchon plastique
Check coupling male thread bsp with o'ring
Presa di pressione BSP con o'ring

ROSCA THREAD	REFERENCIA PART N°	€
1/8" BSP	MPR 1/8 C/J	7,67
1/4" BSP	MPR 1/4 C/J	7,77
3/8" BSP	MPR 3/8 C/J	8,35
1/2" BSP	MPR 1/2 C/J	11,17

Racor de control rosca Métrica DIN 3852



Prise de pression métrique avec capouchon plastique
Check coupling male metric thread
Presa di pressione Metrica DIN 3852

ROSCA THREAD	REFERENCIA PART N°	€
M12X1.5	MPR M12X1.5	7,67
M14X1.5	MPR M14X1.5	8,50
M16X1.5	MPR M16X1.5	7,57

Racor de control rosca BSP



Prise de pression avec capouchon plastique
Check coupling male thread bsp
Presa di pressione BSP

ROSCA THREAD	REFERENCIA PART N°	€
1/8" BSP	MPR 1/8 G	7,67
1/4" BSP	MPR 1/4 G	7,57
3/8" BSP	MPR 3/8 G	8,16

Racor de control rosca Métrica (cónica)



Prise de pression métrique avec capouchon plastique
Check coupling male metric thread
Presa di pressione Metrica (conica)

ROSCA THREAD	REFERENCIA PART N°	€
M8X1	MPR A 8X1	7,67
M10X1	MPR A 10X1	7,67
M10X1.25	MPR A 10X1.25	7,67

Racor de control rosca cónica BSPT



Prise de pression BSPT avec capouchon plastique
Check coupling male BSP tapered
Presa di pressione conica BSPT

ROSCA THREAD	REFERENCIA PART N°	€
1/8" BSPT	MPR 1/8 BSPT	7,82
1/4" BSPT	MPR 1/4 BSPT	7,67
3/8" BSPT	MPR 3/8 BSPT	16,75

Racor de control tubular Métrico



Prise de pression avec embout lisse capouchon plastique
Check coupling male metric tubular
Presa di pressione con tubolare Metrico

TUBO PIPE	REFERENCIA PART N°	€
6	MPR TUB.6	7,38
8	MPR TUB.8	7,38
10	MPR TUB.10	7,38
12	MPR TUB.12	7,38
15	MPR TUB.15	7,77

Racor de control rosca NPT



Prise de pression NPTF avec capouchon plastique
Check coupling male thread NPT
Presa di pressione NPTF

ROSCA THREAD	REFERENCIA PART N°	€
1/8" NPT	MPR 1/8 NPT	7,91
1/4" NPT	MPR 1/4 NPT	7,67
3/8" NPT	MPR 3/8 NPT	9,61

Racor de control rosca SAE - UNF



Prise de pression filetage SAE/UNF avec capouchon plastique
Check coupling male thread UNF
Presa di controllo SAE - UNF

ROSCA THREAD	REFERENCIA PART N°	€
7/16" 20h UNF	MPR 7/16 UNF	7,67
1/2" 20h UNF	MPR 1/2 UNF	8,93
9/16" 18h UNF	MPR 9/16 UNF	7,67

Racores de control

Prise de control
Checking fittings
Prese di pressione

Hoses

Flexible hose fittings

Stainless steel hoses and fittings

Low pressure

Air conditioned hoses and fittings

Measuring flow

Machines for mounting flexibles

Racor de control hembra giratoria Métrica con junta (metalico)



Prise de pression femelle tournante Métrique + o´ring (metalique)
Check coupling Metric swivel female + o´ring (metallic)
Presse di pressione femmina girevole Metrica con o´ring

TUBO PIPE	ROSCA THREAD	REFERENCIA PART N°	€
10L	M16X1.5	MPR TLM 10L CM	16,90
12L	M18X1.5	MPR TLM 12L CM	15,56
15L	M22X1.5	MPR TLM 15L CM	17,67

Racor de control macho Métrico con junta (metalico)



Prise de pression mâle + o´ring (metalique)
Check coupling metric male + o´ring (metallic)
Presse di pressione maschio Metrico con o´ring

ROSCA THREAD	REFERENCIA PART N°	€
M10X1	MPR M 10X1 CM	8,22
M12X1.5	MPR M 12X1.5 CM	9,52

Conex. manómetro-pasatabiques BSP



Prise de pression passe cloison sans capuchon
Check coupling BSP bulkhead for manometer
Raccordo Manometro - passaparete maschio BSP

ROSCA THREAD	REFERENCIA PART N°	€
1/4" BSP	MPR PT 1/4 BSP	11,07
1/2" BSP	MPR PT 1/2 BSP	15,73

Capuchón protector toma de presión

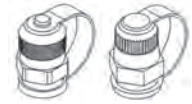

Capuchon plastique Minimesse
Protective cap - check coupling for manometer
Cappuccio di protezione per presa di pressione

CAPUCHON CAPS	REFERENCIA PART N°	€
ACERO	27CA0000	2,66
PLASTICO	28CP0000	1,46

Conex. Métrica para manómetros



Prise de control metrique pour manometre
Metric check coupling for manometer
Presse di pressione metrica per manometro

TUBO PIPE	ROSCA THREAD	REFERENCIA PART N°	€
8S	M16X1.5	MPR PT 16X1.5	16,80
10S	M18X1.5	MPR PT 18X1.5	19,91

Conex. manómetro - toma de control



Raccord de control direct à manomètre sans capuchon
Check coupling for manometer
Raccordo manometro - presa di pressione

ROSCA THREAD	REFERENCIA PART N°	€
1/4" BSP	MPD 1/4 BSP	12,24
1/2" BSP	MPD 1/2 BSP	15,15

Conex. manómetro-hembra 90° BSP



Raccord de control 90° orientable sans capuchon directs à manomètre
Check coupling 90° BSP swivel female for manometer
Raccordo manometro - femmina a 90° BSP

ROSCA THREAD	REFERENCIA PART N°	€
1/4" BSP	MPD 90 1/4 BSP	13,79
1/2" BSP	MPD 90 1/2 BSP	15,54

Tomas de manómetros

Embouts manomètres
Manometers fittings
Raccordi per manometri

Mangueras Minimess



Tuyaux Minimess

Micro-Hose hose

Micro-tubo per presa di pressione

Ø int	REFERENCIA PART N°	€
2	M089K02	3,18

Casquillo manguera Minimess

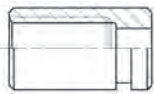

Jupe pour tuyau Minimess

Micro-hose ferrules

Boccola per Micro-tubo

DN	REFERENCIA PART N°	€
2	555010100	0,68

Hembra giratoria de control

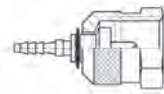

Embout femelle tournante de control Métrique Minimess

Check swivel female BSP Micro-hose

Presa di pressione femmina

DN	ROSCA THREAD	REFERENCIA PART N°	€
2	M16X1.5	555069521	5,34
2	M16X2	555069523	5,34

Hembra giratoria recta BSP

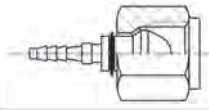

Embout femelle tournante gaz cyl BSP 60° Minimess

Straight swivel female BSP 60° cone Micro-hose

Femmina girevole BSP

DN	ROSCA THREAD	REFERENCIA PART N°	€
2	1/8" BSP	555040202	5,15
2	1/4" BSP	555040404	5,05
2	3/8" BSP	555040606	10,49

Hembra asiento plano con junta manómetro

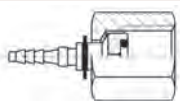

Embout femelle tournante fond plat + o'ring pour manomètre Minimess

Swivel female flat seat with o'ring for manometer Micro-hose

Femmina sede piana con o'ring per manometro

DN	ROSCA THREAD	REFERENCIA PART N°	€
2	1/4" BSP	555050404	5,05
2	1/2" BSP	555050808	9,61

Hembra giratoria Métrica con junta

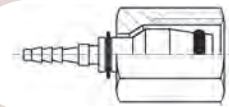

Embout femelle tournante Métrique 24° pour raccord de control + o'ring minimess

Metric swivel female with o'ring

Femmina Metrica 24° con o'ring

DN	TUBO PIPE	ROSCA THREAD	REFERENCIA PART N°	€
2	6L	M12X1.5	555079510	5,44
2	6S	M14X1.5	555079511	5,44
2	8L	M14X1.5	555079512	5,44
2	8S	M16X1.5	555079523	5,44

Macho de control

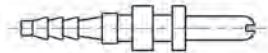

Embout mâle manomètre

Straight Micro-hose check male

Presa di pressione maschio

DN	REFERENCIA PART N°	€
2	555030325	4,37

Espiga lisa Métrica

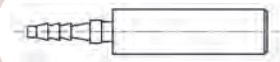

Embout lisse Métrique Minimess

Metric standpipe Micro-hose

Estremità tubolare Metrica

DN	TUBO PIPE	REFERENCIA PART N°	€
2	6	555070600	3,30
2	8	555070800	4,95

Espiga a 90° lisa Métrica



Embout lisse coude 90° Métrique Minimess

90° Metric standpipe Micro-hose

Estremità tubolare a 90° Metrica

DN	TUBO PIPE	REFERENCIA PART N°	€
2	6	555170600	8,64

Tomas de manómetros

Embouts manomètres
Manometers fittings
Raccordi per manometri

Hoses

Hembra giratoria recta JIC 37°

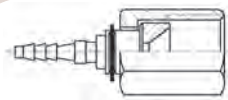

Embout femelle tournante JIC 37° Minimes
Straight swivel female JIC 37° Micro-hose
Femmina diritta JIC 37°

DN	ROSCA THREAD	REFERENCIA PART N°	€
2	7/16" 20h UNF	555090700	5,63
2	1/2" 20h UNF	555090800	5,63

Flexible hose fittings

Orientable Métrico



Embout Banjo Métrique Minimes
Metric Banjo Micro-hose
Raccordo ad occhio Metrico

DN	ROSCA THREAD	REFERENCIA PART N°	€
2	M10X1	555081000	16,70

Stainless steel hoses
and fittings

Protector de polvo



Protecteur de poussière
Dust protector
Protezione per polvere

Descripción Description	REFERENCIA PART N°	€
PLASTICO	54000000P	0,44

Macho NPT

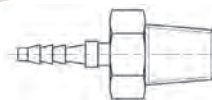

Male NPT
Male NPT
Maschio NPT

DN	ROSCA THREAD	REFERENCIA PART N°	€
2	1/8" NPT	555130200	7,09

Low pressure

Air conditioned hoses
and fittings

Measuring flow

Machines for
mounting flexibles

Manómetros y vacuómetros

Manomètres et vacuomètres
Manometers and vacuum gauges
Manometri e vacuometri

Manómetro DN 63 vertical



Manomètre DN 63 sortie verticale
Manometer DN 63 vertical with glycerin
Manometro DN 63 radiale a bagno di glicerina

ROSCA THREAD	ESCALA (bar) SCALE (bar)	REFERENCIA PART N°	€
1/4" BSP	0-1	MF16304001V	17,70
1/4" BSP	0-2.5	MF163042.5V	15,46
1/4" BSP	0-4	MF16304004V	15,46
1/4" BSP	0-6	MF16304006V	15,46
1/4" BSP	0-10	MF16304010V	15,46
1/4" BSP	0-12	MF16304012V	15,46
1/4" BSP	0-16	MF16304016V	15,46
1/4" BSP	0-20	MF16304020V	15,46
1/4" BSP	0-25	MF16304025V	15,46
1/4" BSP	0-40	MF16304040V	15,46
1/4" BSP	0-60	MF16304060V	17,36
1/4" BSP	0-100	MF16304100V	17,36
1/4" BSP	0-160	MF16304160V	17,36
1/4" BSP	0-250	MF16304250V	17,36
1/4" BSP	0-315	MF16304315V	17,36
1/4" BSP	0-400	MF16304400V	17,36
1/4" BSP	0-600	MF16304600V	18,28

Manómetro DN 100 vertical



Manomètre DN 100 sortie verticale
Manometer DN 100 vertical with glycerin
Manometro DN 100 radiale a bagno di glicerina

ROSCA THREAD	ESCALA (bar) SCALE (bar)	REFERENCIA PART N°	€
1/2" BSP	0-1	MF110008001V	37,81
1/2" BSP	0-2.5	MF11000802.5V	36,56
1/2" BSP	0-4	MF110008004V	36,56
1/2" BSP	0-6	MF110008006V	36,56
1/2" BSP	0-10	MF110008010V	36,56
1/2" BSP	0-12	MF110008012V	36,56
1/2" BSP	0-16	MF110008016V	36,56
1/2" BSP	0-20	MF110008020V	36,56
1/2" BSP	0-25	MF110008025V	36,56
1/2" BSP	0-40	MF110008040V	36,56
1/2" BSP	0-60	MF110008060V	37,72
1/2" BSP	0-100	MF110008100V	37,72
1/2" BSP	0-160	MF110008160V	37,72
1/2" BSP	0-250	MF110008250V	37,72
1/2" BSP	0-315	MF110008315V	37,72
1/2" BSP	0-400	MF110008400V	37,72
1/2" BSP	0-600	MF110008600V	40,53

Manómetro DN 63 dorsal



Manomètre DN 63 sortie arrière
Manometer DN 63 dorsal with glycerin
Manometro DN 63 assiale flangiato a bagno di glicerina

ROSCA THREAD	ESCALA (bar) SCALE (bar)	REFERENCIA PART N°	€
1/4" BSP	0-1	MF16304001-DB	18,49
1/4" BSP	0-2.5	MF163042.5-DB	18,52
1/4" BSP	0-4	MF16304004-DB	18,52
1/4" BSP	0-6	MF16304006-DB	18,52
1/4" BSP	0-10	MF16304010-DB	18,52
1/4" BSP	0-12	MF16304012-DB	18,52
1/4" BSP	0-16	MF16304016-DB	18,52
1/4" BSP	0-20	MF16304020-DB	18,52
1/4" BSP	0-25	MF16304025-DB	18,52
1/4" BSP	0-40	MF16304040-DB	18,52
1/4" BSP	0-60	MF16304060-DB	20,52
1/4" BSP	0-100	MF16304100-DB	20,52
1/4" BSP	0-160	MF16304160-DB	20,52
1/4" BSP	0-250	MF16304250-DB	20,52
1/4" BSP	0-315	MF16304315-DB	20,52
1/4" BSP	0-400	MF16304400-DB	20,52
1/4" BSP	0-600	MF16304600-DB	20,85

Manómetro DN 100 dorsal



Manomètre DN 100 sortie arrière
Manometer DN 100 dorsal with glycerin
Manometro DN 100 assiale flangiato a bagno di glicerina

ROSCA THREAD	ESCALA (bar) SCALE (bar)	REFERENCIA PART N°	€
1/2" BSP	0-1	MF110008001-DB	40,18
1/2" BSP	0-2.5	MF1100082.5-DB	39,61
1/2" BSP	0-4	MF110008004-DB	39,61
1/2" BSP	0-6	MF110008006-DB	39,61
1/2" BSP	0-10	MF110008010-DB	39,61
1/2" BSP	0-16	MF110008016-DB	39,61
1/2" BSP	0-25	MF110008025-DB	39,61
1/2" BSP	0-40	MF110008040-DB	39,61
1/2" BSP	0-60	MF110008060-DB	40,86
1/2" BSP	0-100	MF110008100-DB	43,08
1/2" BSP	0-160	MF110008160-DB	40,86
1/2" BSP	0-250	MF110008250-DB	40,86
1/2" BSP	0-315	MF110008315-DB	40,86
1/2" BSP	0-400	MF110008400-DB	40,86
1/2" BSP	0-600	MF110008600-DB	43,10

Manómetro de colores



Manomètre à couleurs
Pressure gauges in colours
Manometro a colori

ROSCA THREAD	ESCALA (bar) SCALE (bar)	REFERENCIA PART N°	€
1/8	0-6	MFI CO 06	6,70

Manómetros y vacuómetros

Manomètres et vacuomètres
Manometers and vacuum gauges
Manometri e vacuometri

Hoses

Vacuómetro DN 63 con glicerina Inox



Vacuomètre DN 63 glycerine boîtier Inox
Vacuum gauge DN 63 with glycerin
Vacuometro DN 63 a bagno di glicerina

ROSCA THREAD	ESCALA (bar) SCALE (bar)	REFERENCIA PART N°	€
1/4" BSP	-1-0	VAC6304-01I	17,70
1/4" BSP	-76-0	VAC6304-76I	17,71

Vacuómetro de colores



Vacuomètre à couleurs
Vacuum gauges in colours
Vacuometro a colori

ROSCA THREAD	ESCALA (bar) SCALE (bar)	REFERENCIA PART N°	€
1/8	-1-0	MFI VA 01	10,26

Flexible hose fittings

Stainless steel hoses and fittings

Maletín medida de presión (3 manómetros)



Coffre de mesure (3 manomètre)
Check cases (3 manometer)

Valigetta misurazione di pressione (3 manometro)

TAMAÑO SIZE	ESCALA (bar) SCALE (bar)	REFERENCIA PART N°	€
320x280x119	0-25;0-160;0-400	CBOXMED3	466,10

Maletín medida de presión (0 manómetros)



Coffre de mesure (0 manomètre)
Check cases (0 manometer)

Valigetta misurazione di pressione (0 manometro)

TAMAÑO SIZE	ESCALA (bar) SCALE (bar)	REFERENCIA PART N°	€
320x280x119	-	CBOXMEDF	58,26

Low pressure

Maletín medida de presión (4 manómetros)



Coffre de mesure (4 manomètre)
Check cases (4 manometer)

Valigetta misurazione di pressione (4 manometro)

TAMAÑO SIZE	ESCALA (bar) SCALE (bar)	REFERENCIA PART N°	€
320x280x119	0-25;0-100;0-315;0-600	CBOXMED4	630,98

Air conditioned hoses and fittings

Measuring flow

Machines for mounting flexibles

Medidores de caudal

Debimètres
Flow tester
Indicatori di flusso

Caudalímetro 250 bar tipo 3 - 1/2"



Debimètre 250 bar type 3-1/2"
Flow tester type 3-1/2"
Flussostato 250 bar tipo 3-1/2"

ESCALA (l/min) SCALE (l/min)	REFERENCIA PART N°	€
0-56	WPB3A6HT15	497,55

Caudalímetro 250 bar tipo 5 - 1 1/2"



Debimètre 250 bar type 5-1 1/2"
Flow tester type 5-1 1/2"
Flussostato 250 bar tipo 5-1 1/2"

ESCALA (l/min) SCALE (l/min)	REFERENCIA PART N°	€
0-550	WPB5A6HY99	1.995,70

Caudalímetro 250 bar tipo 4 - 1"



Debimètre 250 bar type 4-1"
Flow tester type 4-1"
Flussostato 250 bar tipo 4-1"

ESCALA (l/min) SCALE (l/min)	REFERENCIA PART N°	€
0-150	WPB4A6HV40	861,46

Caudalímetro 400 bar Tipo 57



Debimètre 400 bar Type 57
Flow tester 400 bar Type 57
Flussostato 400 bar Tipo 57

ESCALA (l/min) SCALE (l/min)	REFERENCIA PART N°	€
0-30	FT5758-01	1.198,52
0-60	FT5758-02	1.311,23
0-120	FT5758-03	1.423,93

Caudalímetro 300 bar Tipo 60



Debimètre 300 bar Type 60
Flow tester 300 bar Type 60
Flussostato 300 bar Tipo 60

ESCALA (l/min) SCALE (l/min)	REFERENCIA PART N°	€
0-200	FT6068-01	2.413,53
0-400	FT6068-03	3.015,54

Caudalímetro 400 bar con caja



Debimètre 400 bar avec boîte
Flow tester 400 bar with box
Flussostato 400 bar con cassa

ESCALA (l/min) SCALE (l/min)	REFERENCIA PART N°	€
0-120	FT5594-03	3.128,25
0-180	FT5594-09	3.273,94

Foto-tacómetro



Photo-tachymètre
Photo-tachometer
Foto-tachimetro

Descripción Description	REFERENCIA PART N°	€
Foto-tacómetro digital	DT2238	429,35

Tomas de presión para circuitos ya existentes

Prises de pression pour circuits | Measuring connectors for assembled installations
 Presa di pressione per circuiti già esistenti

Hoses

Flexible hose fittings

Stainless steel hoses and fittings

Low pressure

Air conditioned hoses and fittings

Measuring flow

Machines for mounting flexibles

Montaje en tubos con presión SC1 | Montage sur tubes avec pression SC1 | SC1 for mounting on pressurized pipes | Montaggio su tubi in pressione SC1



Sensor de presión | Capteur de pression | Pressure sensor | Sensore di pressione

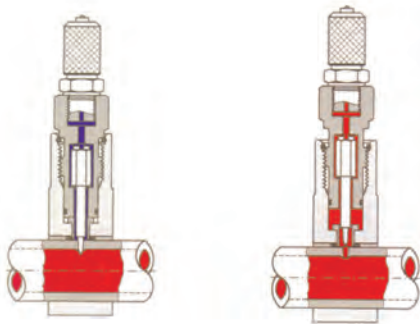

Montaje en tubos sin presión SC2 | Montage en tubes sans pression SC2 | SC2 for mounting on non-pressurized pipes | Montaggio su tubi non in pressione SC2



Sensor de temperatura | Capteur de température | Temperature sensor | Sensore di temperatura
Sensor de presión | Capteur de pression | Pressure sensor | Sensore di pressione
Sensor de caudal | Capteur de débit | Flow rate sensor | Sensore di portata

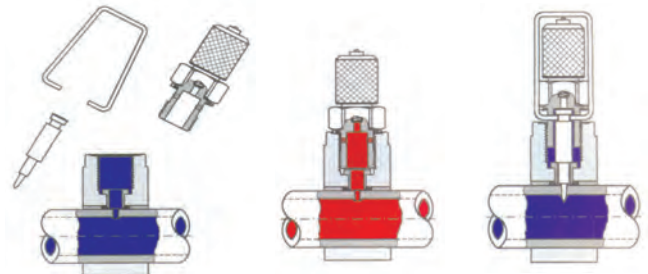

Tomas de presión para circuitos ya existentes

Prises de pression pour circuits | Measuring connectors for assembled installations
Presa di pressione per circuiti già esistenti

Toma de manómetro SC1 para instalación en tubos con presión | Prisse de pression SC1 pour tubes à pression | Measuring connector SC1 for mounting on pressurized pipes | Porta manometro SC1 per installazione su tubi pressione



Referencia Référence Part number Codice	Ø Ext. (mm)	Presión máx. Pression max. Max. pressure Pressione max. (Bar)	€
SC1A10	10	630	356,57
SC1A12	12	630	356,57
SC1A14	14	630	356,57
SC1A15	15	630	356,57
SC1A16	16	630	356,57
SC1A18	18	630	356,57
SC1A20	20	630	376,63
SC1A22	22	630	376,63
SC1A25	25	630	376,63
SC1A28	28	630	376,63
SC1A30	30	630	392,23
SC1A35	35	630	392,23
SC1A38	38	630	392,23
SC1A42	42	630	392,23

Toma de manómetro SC2 para instalación en tubos sin presión | Prisse de pression SC2 pour tubes sans pression | Measuring connector SC2 for mounting on non-pressurized pipes | Porta manometro SC2 per installazione su tubi senza pressione



Referencia Référence Part number Codice	Ø Ext. (mm)	Presión máx. Pression max. Max. pressure Pressione max. (Bar)	€
SC2A10	10	630	218,40
SC2A12	12	630	218,40
SC2A14	14	630	218,40
SC2A15	15	630	218,40
SC2A16	16	630	218,40
SC2A18	18	630	218,40
SC2A20	20	630	247,37
SC2A22	22	630	247,37
SC2A25	25	630	247,37
SC2A28	28	630	247,37
SC2A30	30	630	276,34
SC2A35	35	630	276,34
SC2A38	38	630	276,34
SC2A42	42	630	276,34

Sensores | Capteurs | Sensors | Sensori



Referencia Référence Part number Codice	Descripción Description Description Descrizione	Presión máx. Pression max. Max. pressure Pressione max. (Bar)	€
TS1A1203/8	Sensor temperatura para SC2 Capteur de temperature pour SC2 Temperature sensor suitable for SC2 Sensore di temperatura	630	797,83
DS1A4001/4	Sensor presión para SC1 Capteur de temperature pour SC1 Pressure sensor suitable for SC1 Sensore di pressione per SC1	630	842,40
DS1A4003/8	Sensor presión para SC2 Capteur de pression pour SC2 Pressure sensor suitable for SC2 Sensore di pressione per SC2	630	842,40
QS2B0083/8	Sensor de caudal para SC2 * Calibración, consultar Capteur de flux pour SC2 * Calibrage, consulter Flow rate sensor suitable for SCS * Calibration service, on request Sensore di portata per SC2 * Regolazione a richiesta	630	1.938,86

Maletín servicios hidráulicos | Coffret pour services hydrauliques | Hydraulic services suitcase | Valigetta servizi idraulici



Referencia Référence Part number Codice	Contenido Contenu Contents Contenuto	€
MSC01	8 x SC1	2.861,49
MSC02	8 x SC2	1.880,91
MSC03	3 x SC1 + 3 x SC2 2 x sensores DS/TS	3.342,86

Kit de medida con indicador digital (2 inputs analógicos) | Kit de mesure avec indicateur numérique (2 intrants analogique) | Measurement kit with digital gauge | Kit di misurazione con indicatore digitale (2 entrate analogiche)



Referencia Référence Part number Codice	€
FM1B	2.450

7

Máquinas para flexibles. Prensas manuales

Machines pour flexibles. Presses manuelles | Machines for flexibles. Manual crimping machines | Macchine per tubi flessibili. Presse manuale

Hoses

Flexible hose fittings

Stainless steel hoses and fittings

Low pressure

Air conditioned hoses and fittings

Measuring flow

Machines for mounting flexibles

V001040



PHM2 12 (3/4" R2) - PHM2 16 (1" R2)

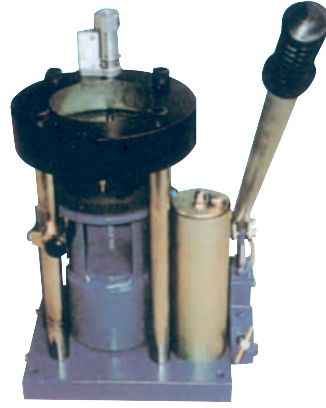

PEA 16 (1" R2)



SM2



90 t +22 mm 75 mm

S2P

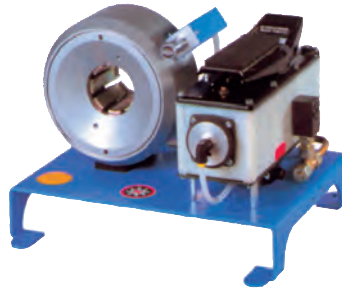

90 t +22 mm 75 mm

Máquinas para flexibles. Prensas horizontales sobre mesa

Machines pour flexibles. Presses horizontales avec support | Machines for flexibles. Horizontal crimping machines with support | Macchine per tubi flessibili. Presse orizzontale sul tavolo

▶ **SE 25 (12 4SP)**



120 t +18 mm 98 mm

▶ **PE 28 1" 1/4 4 SP)**



137 t +28 mm 100 mm

▶ **PE 32 1" 1/4 6 SP)**



207 t +38 mm 118 mm

▶ **PE 38 (2" 4 SP)**



204 t +38 mm 118 mm

▶ **PE 50/2**



300 +38 mm 160 mm

▶ **PE 58 (2" 6 SP)**



305 t +54 mm 180 mm

▶ **PE 38 12V (2" 4 SP)**



240 t +38 mm 118 mm

▶ **SPEBDEG**



▶ **SRC**



Hoses

Flexible hose fittings

Stainless steel hoses and fittings

Low pressure

Air conditioned hoses and fittings

Measuring flow

Machines for mounting flexibles

Máquinas para flexibles. Presas horizontales

Machines pour flexibles. Presse horizontales | Machines for flexibles. Horizontal crimping machines | Macchine per tubi flessibili. Presse orizzontale

Hoses

Flexible hose fittings

Stainless steel hoses and fittings

Low pressure

Air conditioned hoses and fittings

Measuring flow

Machines for mounting flexibles

▶ **HM 220**



140 t +35 mm 105 mm

▶ **PES 32 (1" 1/4 4 SP)**



140 t +45 mm 124 mm

▶ **PES 50 (2" 6 SP)T**



280 t +70 mm 147 mm

▶ **PES 125 (3" 6 SP)**



400 t +85 mm 212 mm

▶ **PESO 320 (6")**



320 t +55 mm 260 mm

▶ Máquinas para flexibles. Cortadoras

Machines pour flexibles. Tronçonneuse | Machines for flexibles. Cutting machines | Macchine per tubi flessibili. Taglierine

▶ **CHM2-20D (1" 1/4)**



Ø Disco-250mm
Pot. Motor 2,2 KW

▶ **CHM4-32D (2")**



▶ **TS 50 (2" 6SP)**



▶ **MN500SW (hasta 1" 1/2)**



▶ **MN450 (hasta 3/4")**



Hoses

Flexible hose fittings

Stainless steel hoses
and fittings

Low pressure

Air conditioned hoses
and fittings

Measuring flow

Machines for
mounting flexibles

Máquinas para flexibles. Otras máquinas

Machines pour flexibles. D'autres machines | Machines for flexibles. Other machines | Macchine per tubi flessibili. Altre macchine

Hoses

Flexible hose fittings

Stainless steel hoses and fittings

Low pressure

Air conditioned hoses and fittings

Measuring flow

Machines for mounting flexibles

- **Banco de pruebas BE 1500 / BE 2500** | Banque d'essais BE 1500 / BE 2500
Testing bank BE 1500 / BE 2500 | Banco de prova BE 1500 / BE 2500



Opcional | Optionnel |
Optional | Opzionale

- **Marcadora MMJ 50** | Machine de marquage
Marking machine | Marcatrice



- **Marcadora UP 100** | Machine de marquage
Marking machine | Marcatrice



- **PEP 158**



102 t +28 mm 156 mm

- **Banco limpieza RG1** | Banque de nettoyage
Cleaning bank | Banca per la pulizia



- **Banco limpieza portátil RG2**
Banque de nettoyage portable
Portable cleaning bank
Banca per la pulizia portabile



▶ Máquinas para flexibles. Accesorios para prensas

Machines pour flexibles. Accessoires pour machines à sertir | Machines for flexibles. Accessories for crimping machines | Macchine per tubi flessibili. Accessori per presse

▶ **EG**



▶ **CME**



▶ **Garras especiales** | Mors spécial
Special gags | Morssetti speciale



▶ **Computer**



▶ **BSA**



▶ **Topo trasero** | Butée arrière
Back stop | Fermata posteriore

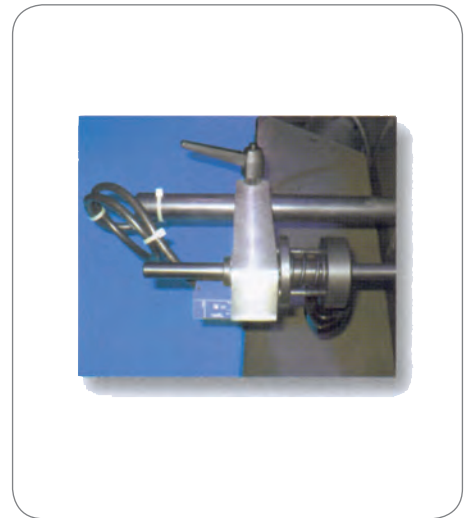

▶ **Portarrollos** | Porte-Rouleaux
Roll-Holder | Portarotoli

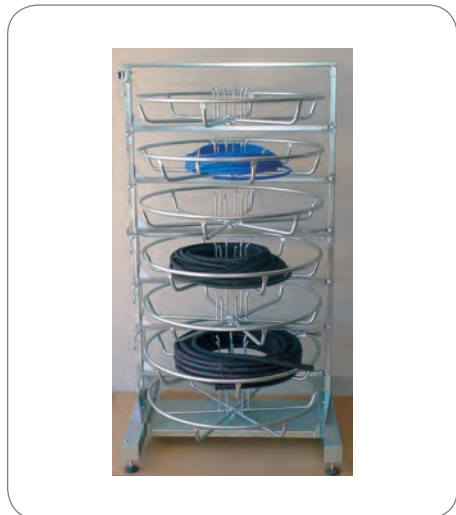

Hoses

Flexible hose fittings

Stainless steel hoses and fittings

Low pressure

Air conditioned hoses and fittings

Measuring flow

Machines for mounting flexibles

Peladoras

Denudeuses | Skive machines | Spellatubi

Hoses

Flexible hose fittings



PBC-32

Peladora con mueble hasta 2". Opción estándar | Skiving machine up to 2", standard option

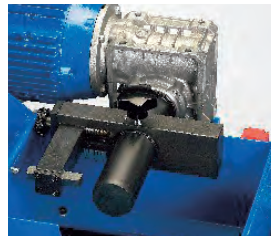

PBCM-32

Peladora con mueble. Opción MS | Skiving machine, MS option



Capacidad pelado exterior External skiving	2"
Capacidad pelado interior Internal skiving	2"
R.P.M. R.P.M.	300
Alimentación neumática Pneumatic input	Máx. 7 Bar
Potencia motor Engine power	0,75 KW

Opcional | Optionnel | Optional | Opzionale

Mordaza neumática | Pneumatic clamp



Portaherramientas | Tool holder



Mueble portaherramientas | Tool holder cabinet



Stainless steel hoses and fittings

Low pressure

PB-32

Peladora sin mueble hasta 2" | Skiving machine up to 2"



Capacidad pelado exterior External skiving	2"
Capacidad pelado interior Internal skiving	2"
R.P.M. R.P.M.	300
Potencia motor Engine power	0,75 KW

Portaherramientas (opcional) | Tool holder (optional)



Air conditioned hoses and fittings

Measuring flow

Otras máquinas: consultar | Autres machines, sur demande | Other machines, on request | Altre macchine, sur richiesta



HST 50



PBCMU-32

Machines for mounting flexibles